

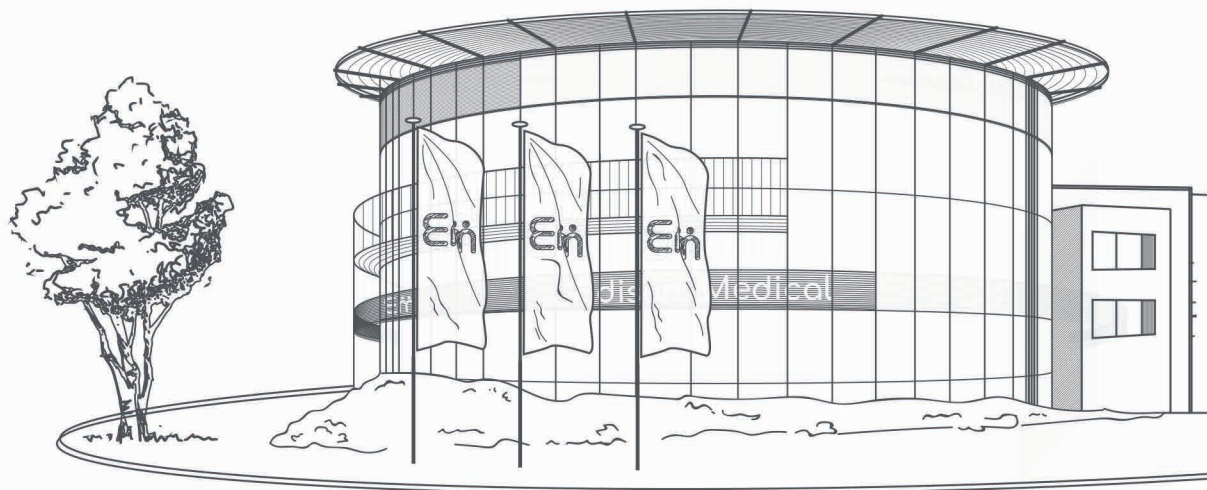

PRODUCT CATALOG 2019



Edison Medical.





Implants Characteristics	2
■ Conical Connection 4 - 50	
Implants - Artic	5
Implants - Fortis	6
Implants - ios3	7
Impression & Lab Components	8
Healing Abutments	11
Temporary Abutments	12
Straight Titanium Abutments	14
Angled Titanium Abutment 15°	15
Angled Titanium Abutment 25°	16
Clicq™ Pression - Titanium Transfer Abutments	17
Pop Clicq™ - Overdenture Attachments	22
Pop Clicq™ - Bar	27
Multi Clicq™ - On 4 / On 6	29
Clicq™ - Multi Bar - On 4 / On 6	37
Zircocam™	39
Zircotec™	41
Casting Abutments / UCLA	42
Digital Solutions CAD/CAM	45
Abutment Gauges	49
■ Internal Hex 51 - 74	
Implants - Lamina	52
Impression & Lab Components	53
Healing Abutments	54
Temporary Abutments	55
Titanium Abutments	56
Clicq™ Pression - Titanium Transfer Abutments	59
Pop Clicq™ - Overdenture Attachments	61
Pop Clicq™ - Bar	63
Ball Attachments	64
Q Clicq™ - Overdenture Attachments	65
Multi Clicq™ - On 4 / On 6	67
Clicq™ - Multi Bar - On 4 / On 6	70
Zircocam™ & Zircotec™	71
Casting Abutments & UCLA	72
Digital Solutions CAD/CAM	73
Abutment Gauges	74
■ Tools 75 - 86	
Implant Drivers	76
Screw Drivers	78
Drills	80
Various Tools	83
Surgical Tool Box - Artic	84
Surgical Tool Box - Fortis & iso3	85
Surgical Tool Box - Lamina	86



Simplicity!
One implant design
various connections

Build-in Platform Switching

Prevent crestal bone loss, which is fundamental for long-term success and stability. It increases the volume of soft tissue around the implant platform, helping to improve the aesthetic final result. As well as reduces the amount of stress transferred from the abutment to the bone.

Micro Rings

Tapered coronal design and micro rings designed to reduce bone stress and minimize bone resorption to optimize bone and soft tissue volume.

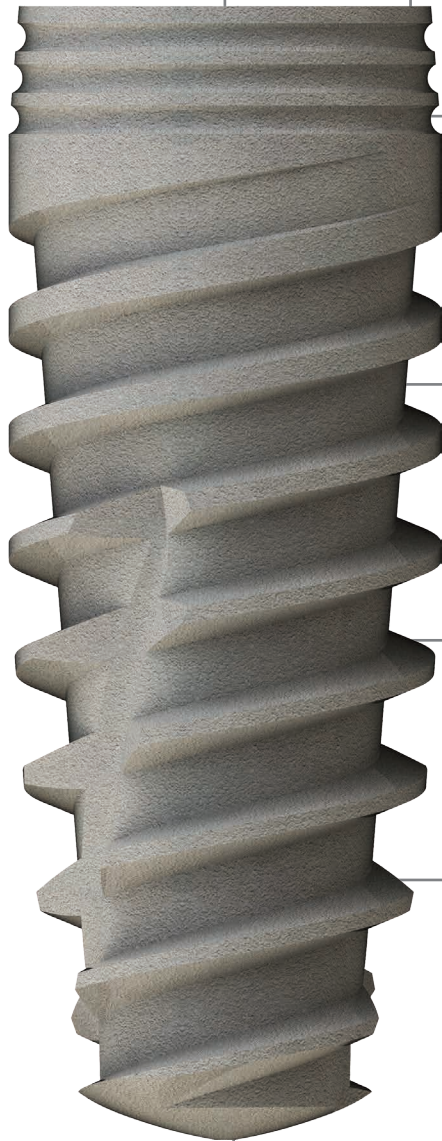

Dual Threads

Tapered implant body & core with dual threads and optimal pitch of 1.0mm for faster implant insertion with better stability.

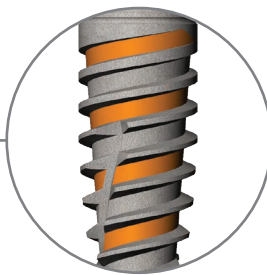

Initial Stability

Progressive threads with compression properties and drilling blades on the apex enable to adjust the implant position during placement.

Implant Surface

Proper implant surface is the key for optimal Osseointegration. Our unique process is a combination of Sandblasted Large grit particles and Acid etched. The roughened micro & nano surface structure improve bone adhesion that significantly increase surface area of the implant body for optimal osseointegration.

Safe Insertion

Curved passive apex allows safe implant insertion without the risk of damage to the surrounding.

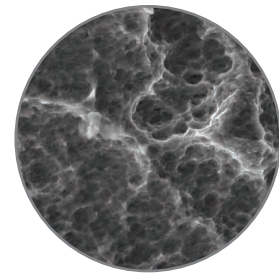

TI 6AL 4V-ELI Titanium Alloy for Implants
Made in Germany

* Registered trademarks are owned by their respective companies and there is no commercial relationship with Edison Medical. Its mention is made for proper identification purpose of the dental implants with which the Edison Medical abutments can be used.

Implant's Characteristics

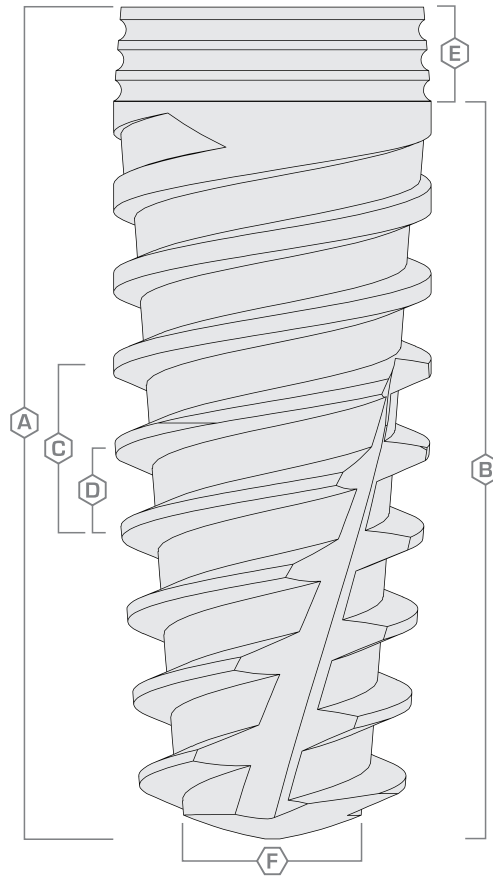

Platform	-A- Overall height	-B- Thread height	-C- Thread pitch	-D- Thread spacing	-E- Collar height	-F- Tip diameter
Ø 3.1mm	10	9.5	8.3	2.2	1.1	2.0
	11.5	11	9.8	2.2	1.1	2.0
	13	12.5	11.3	2.2	1.1	2.0
	15	14.5	13.3	2.2	1.1	2.0
Ø 3.5mm Ø 3.6mm	8	8	6.8	2.2	1.1	2.1
	10	9.5	8.3	2.2	1.1	2.1
	11.5	11	9.8	2.2	1.1	2.1
	13	12.5	11.3	2.2	1.1	2.1
Ø 4.2mm Ø 4.3mm	15	14.5	13.3	2.2	1.1	2.1
	8	8	6.8	2.2	1.1	2.7
	10	9.5	8.3	2.2	1.1	2.7
	11.5	11	9.8	2.2	1.1	2.7
Ø 5.0mm	13	12.5	11.3	2.2	1.1	2.7
	8	8	6.8	2.2	1.1	3.2
	10	9.5	8.3	2.2	1.1	3.2
	11.5	11	9.8	2.2	1.1	3.2
	13	12.5	11.3	2.2	1.1	3.2

* Registered trademarks are owned by their respective companies and there is no commercial relationship with Edison Medical. Its mention is made for proper identification purpose of the dental implants with which the Edison Medical abutments can be used.



***Conical
Connection***





Artic®



ACTIVE HEX
Conical Connection
NobelActive™ Compatible*



Artic®

Narrow Platform

Ø	L	3.5mm
8mm		AR-NA-NP3508
10mm		AR-NA-NP3510
11.5mm		AR-NA-NP3511
13mm		AR-NA-NP3513
15mm		AR-NA-NP3515



Regular Platform

Ø	L	4.3mm	5.0mm
8mm		AR-NA-RP4308	AR-NA-RP5008
10mm		AR-NA-RP4310	AR-NA-RP5010
11.5mm		AR-NA-RP4311	AR-NA-RP5011
13mm		AR-NA-RP4313	AR-NA-RP5013
15mm		AR-NA-RP4315	

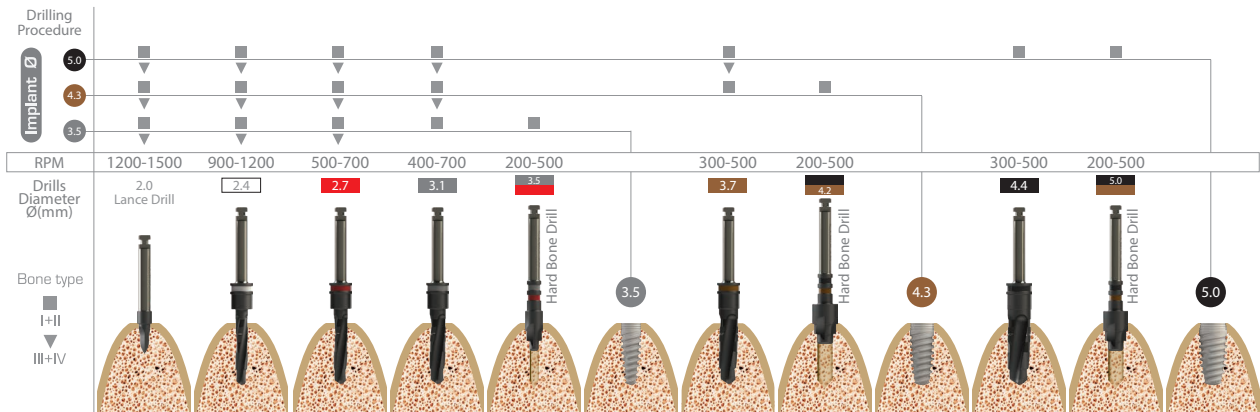

* Registered trademarks are owned by their respective companies and there is no commercial relationship with Edison Medical. Its mention is made for proper identification purpose of the dental implants with which the Edison Medical abutments can be used.



Fortis®



STREAMLINE
Conical Connection

Osstem® Hiossen® Compatible*

Regular Platform

Ø L	3.6mm	4.2mm	5.0mm
8mm	FR-TS-RP3508	FR-TS-RP4208	FR-TS-RP5008
10mm	FR-TS-RP3510	FR-TS-RP4210	FR-TS-RP5010
11.5mm	FR-TS-RP3511	FR-TS-RP4211	FR-TS-RP5011
13mm	FR-TS-RP3513	FR-TS-RP4213	FR-TS-RP5013
15mm	FR-TS-RP3515	FR-TS-RP4215	

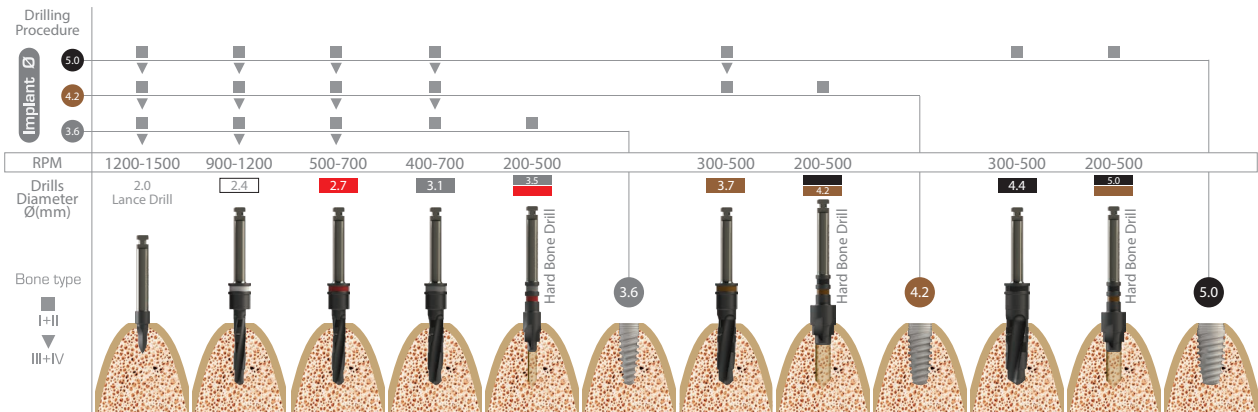

* Registered trademarks are owned by their respective companies and there is no commercial relationship with Edison Medical. Its mention is made for proper identification purpose of the dental implants with which the Edison Medical abutments can be used.



ios[®]3



SPEEDY HEX
Conical Connection

Astra Tech™ TX Compatible*

Slim Platform

Ø	3.1mm
L	
10mm	i3-OS-SP3010
11.5mm	i3-OS-SP3011
13mm	i3-OS-SP3013
15mm	i3-OS-SP3015

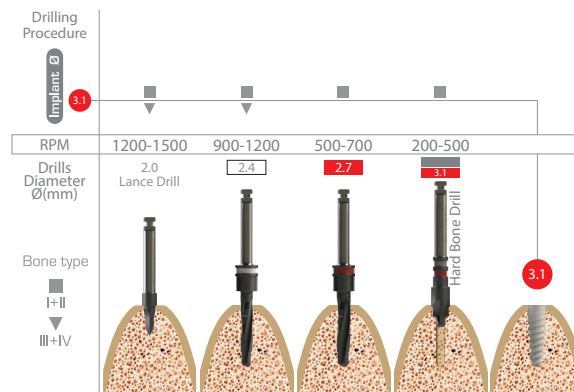

* Registered trademarks are owned by their respective companies and there is no commercial relationship with Edison Medical. Its mention is made for proper identification purpose of the dental implants with which the Edison Medical abutments can be used.



Titanium Implant Analog
Regular Platform

	10mm	15mm	12mm	15.5mm	12mm
NobelActive™ Compatible*	IA-NA-RP				
Osstem® Hiossen® Compatible*	IA-TS-RP				
Dentium® Compatible*	IA-DE-RP				
MegaGen® AnyOne® Compatible*	IA-AO-RP				
MegaGen® AnyRidge® Compatible*	IA-AR-RP				
Astra Tech™TX Compatible*	IA-OS-WP				
Dio Implant® Compatible*	IA-UF-RP				
NeoBiotech® Compatible*	IA-IS-RP				

Titanium Implant Analog
Narrow Platform

	12mm	15mm	15mm
NobelActive™ Compatible*	IA-NA-NP		
Osstem® Hiossen® Compatible*	IA-TS-NP		
Astra Tech™TX Compatible*	IA-OS-SP		

* Registered trademarks are owned by their respective companies and there is no commercial relationship with Edison Medical. Its mention is made for proper identification purpose of the dental implants with which the Edison Medical abutments can be used.



Closed Tray - Slim Body - Ø 3.8mm
Regular Platform

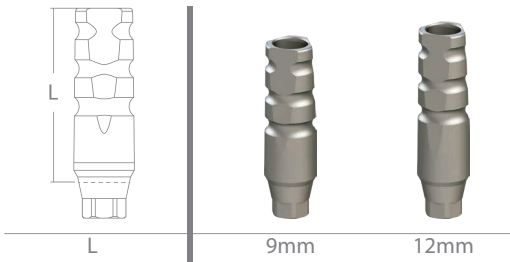

L	9mm	12mm
NobelActive™ Compatible*	CT-NA-RPSN	CT-NA-RPLN
Osstem® Hiossen® Compatible*	CT-TS-RPSN	CT-TS-RPLN
Dentium® Compatible*	CT-DE-RPSN	CT-DE-RPLN
MegaGen® AnyOne Compatible*	CT-AO-RPSN	CT-AO-RPLN
MegaGen® AnyRidge Compatible*	CT-AR-RPSN	CT-AR-RPLN
Astra Tech™TX Compatible*	CT-OS-WPSN	CT-OS-WPLN
Dio Implant® Compatible*	CT-UF-RPSN	CT-UF-RPLN
NeoBiotech® Compatible*	CT-IS-RPSN	CT-IS-RPLN

Closed Tray - Ø 4.5mm
Regular Platform

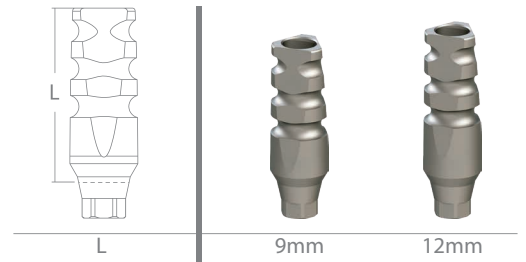

L	9mm	12mm
NobelActive™ Compatible*	CT-NA-RPS	CT-NA-RPL
Osstem® Hiossen® Compatible*	CT-TS-RPS	CT-TS-RPL
Dentium® Compatible*	CT-DE-RPS	CT-DE-RPL
MegaGen® AnyOne Compatible*	CT-AO-RPS	CT-AO-RPL
MegaGen® AnyRidge Compatible*	CT-AR-RPS	CT-AR-RPL
Astra Tech™TX Compatible*	CT-OS-WPS	CT-OS-WPL
Dio Implant® Compatible*	CT-UF-RPS	CT-UF-RPL
NeoBiotech® Compatible*	CT-IS-RPS	CT-IS-RPL



Included

Closed Tray - Slim Body - Ø 3.8mm
Narrow Platform

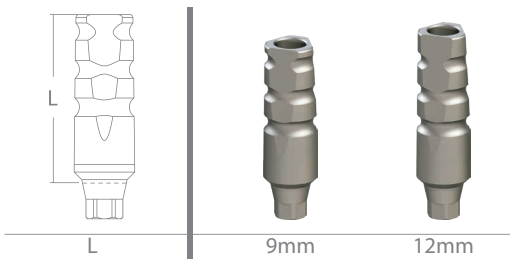

L	9mm	12mm
NobelActive™ Compatible*	CT-NA-NPSN	CT-NA-NPLN
Osstem® Hiossen® Compatible*	CT-TS-NPSN	CT-TS-NPLN
Astra Tech™TX Compatible*	CT-OS-SPSN	CT-OS-SPLN

* Registered trademarks are owned by their respective companies and there is no commercial relationship with Edison Medical. Its mention is made for proper identification purpose of the dental implants with which the Edison Medical abutments can be used.



Open Tray
Regular Platform

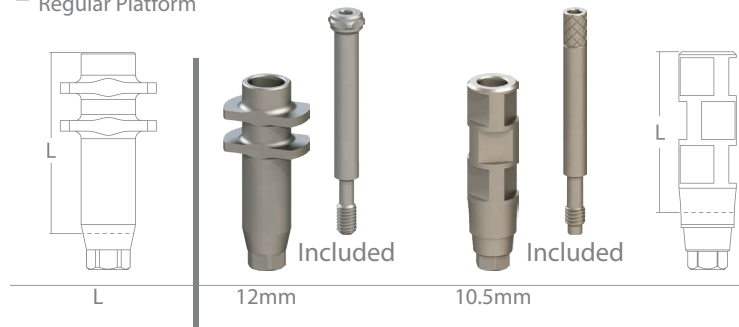

NobelActive™ Compatible *	OT-NA-RP
Osstem® Hiossen® Compatible *	OT-TS-RP
Dentium® Compatible *	OT-DE-RP
MegaGen® AnyOne Compatible *	OT-AO-RP
MegaGen® AnyRidge Compatible *	OT-AR-RP
Astra Tech™TX Compatible *	OT-OS-WP
Dio Implant® Compatible *	OT-UF-RP
NeoBiotech® Compatible *	OT-IS-RP

Open Tray
Narrow Platform

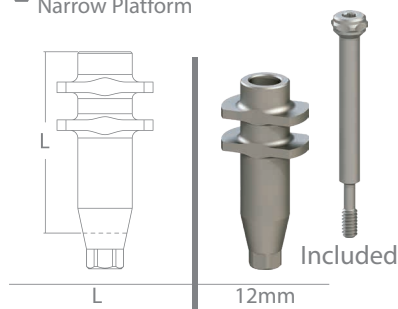

NobelActive™ Compatible *	OT-NA-NP
Osstem® Hiossen® Compatible *	OT-TS-NP
Astra Tech™TX Compatible *	OT-OS-SP

* Registered trademarks are owned by their respective companies and there is no commercial relationship with Edison Medical. Its mention is made for proper identification purpose of the dental implants with which the Edison Medical abutments can be used.



Titanium Healing Abutment
Regular Platform

H Ø	3mm 5mm	3mm 6mm
NobelActive™ Compatible *	HA-NA-RP30N	HA-NA-RP30
Osstem® Hiossen® Compatible *	HA-TS-RP30N	HA-TS-RP30
Dentium® Compatible *	HA-DE-RP30N	HA-DE-RP30
MegaGen® AnyOne Compatible *	HA-AO-RP30N	HA-AO-RP30
MegaGen® AnyRidge Compatible *	HA-AR-RP30N	HA-AR-RP30
Astra Tech™TX Compatible *	HA-OS-WP30N	HA-OS-WP30
Dio Implant® Compatible *	HA-UF-RP30N	HA-UF-RP30
NeoBiotech® Compatible *	HA-IS-RP30N	HA-IS-RP30

Titanium Healing Abutment
Regular Platform

H Ø	5mm 5mm	5mm 6mm
NobelActive™ Compatible *	HA-NA-RP50N	HA-NA-RP50
Osstem® Hiossen® Compatible *	HA-TS-RP50N	HA-TS-RP50
Dentium® Compatible *	HA-DE-RP50N	HA-DE-RP50
MegaGen® AnyOne Compatible *	HA-AO-RP50N	HA-AO-RP50
MegaGen® AnyRidge Compatible *	HA-AR-RP50N	HA-AR-RP50
Astra Tech™TX Compatible *	HA-OS-WP50N	HA-OS-WP50
Dio Implant® Compatible *	HA-UF-RP50N	HA-UF-RP50
NeoBiotech® Compatible *	HA-IS-RP50N	HA-IS-RP50

Titanium Healing Abutment
Narrow Platform

H Ø	3mm 4mm	3mm 5mm
NobelActive™ Compatible *	HA-NA-NP30N	HA-NA-NP30
Osstem® Hiossen® Compatible *	HA-TS-NP30N	HA-TS-NP30
Astra Tech™TX Compatible *	HA-OS-SP30N	HA-OS-SP30

Titanium Healing Abutment
Narrow Platform

H Ø	5mm 4mm	5mm 5mm
NobelActive™ Compatible *	HA-NA-NP50N	HA-NA-NP50
Osstem® Hiossen® Compatible *	HA-TS-NP50N	HA-TS-NP50
Astra Tech™TX Compatible *	HA-OS-SP50N	HA-OS-SP50

* Registered trademarks are owned by their respective companies and there is no commercial relationship with Edison Medical. Its mention is made for proper identification purpose of the dental implants with which the Edison Medical abutments can be used.



Temporary Titanium Abutment
Regular Platform

	12mm	12mm
NobelActive™ Compatible*	TTA-NA-RP	TTA-NA-RPR
Osstem® Hiossen® Compatible*	TTA-TS-RP	TTA-TS-RPR
Dentium® Compatible*	TTA-DE-RP	TTA-DE-RPR
MegaGen® AnyOne Compatible*	TTA-AO-RP	TTA-AO-RPR
MegaGen® AnyRidge Compatible*	TTA-AR-RP	TTA-AR-RPR
Astra Tech™TX Compatible*	TTA-OS-WP	TTA-OS-WPR
Dio Implant® Compatible*	TTA-UF-RP	TTA-UF-RPR
NeoBiotech® Compatible*	TTA-IS-RP	TTA-IS-RPR

Temporary Titanium Abutment
Narrow Platform

	12mm	12mm
NobelActive™ Compatible*	TTA-NA-NP	TTA-NA-NPR
Osstem® Hiossen® Compatible*	TTA-TS-NP	TTA-TS-NPR
Astra Tech™TX Compatible*	TTA-OS-SP	TTA-OS-SPR

* Registered trademarks are owned by their respective companies and there is no commercial relationship with Edison Medical. Its mention is made for proper identification purpose of the dental implants with which the Edison Medical abutments can be used.



PEEK - Straight Abutment
Regular Platform

Medical Peek - Classix

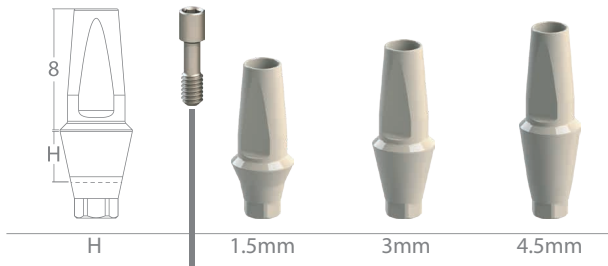

NobelActive™ Compatible*	PA-NA-RP15	PA-NA-RP30	PA-NA-RP45
Osstem® Hiossen® Compatible*	PA-TS-RP15	PA-TS-RP30	PA-TS-RP45
Dentium® Compatible*	PA-DE-RP15	PA-DE-RP30	PA-DE-RP45
MegaGen® AnyOne Compatible*	PA-AO-RP15	PA-AO-RP30	PA-AO-RP45
MegaGen® AnyRidge Compatible*	PA-AR-RP15	PA-AR-RP30	PA-AR-RP45
Astra Tech™TX Compatible*	PA-OS-WP15	PA-OS-WP30	PA-OS-WP45
Dio Implant® Compatible*	PA-UF-RP15	PA-UF-RP30	PA-UF-RP45
NeoBiotech® Compatible*	PA-IS-RP15	PA-IS-RP30	PA-IS-RP45

PEEK - Anatomic Angled Abutment -15°
Regular Platform

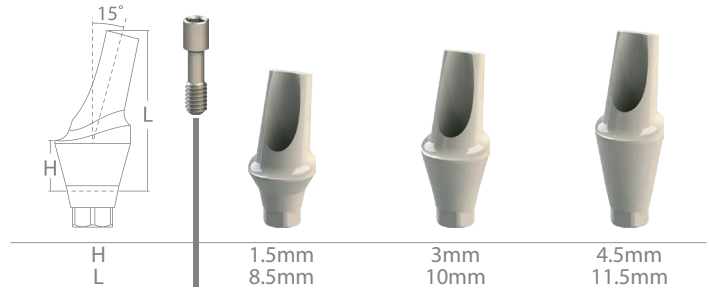

NobelActive™ Compatible*	PAA-NA-RP1515	PAA-NA-RP1530	PAA-NA-RP1545
Osstem® Hiossen® Compatible*	PAA-TS-RP1515	PAA-TS-RP1530	PAA-TS-RP1545
Dentium® Compatible*	PAA-DE-RP1515	PAA-DE-RP1530	PAA-DE-RP1545
MegaGen® AnyOne Compatible*	PAA-AO-RP1515	PAA-AO-RP1530	PAA-AO-RP1545
MegaGen® AnyRidge Compatible*	PAA-AR-RP1515	PAA-AR-RP1530	PAA-AR-RP1545
Astra Tech™TX Compatible*	PAA-OS-WP1515	PAA-OS-WP1530	PAA-OS-WP1545
Dio Implant® Compatible*	PAA-UF-RP1515	PAA-UF-RP1530	PAA-UF-RP1545
NeoBiotech® Compatible*	PAA-IS-RP1515	PAA-IS-RP1530	PAA-IS-RP1545

PEEK - Straight Abutment
Narrow Platform

Medical Peek - Classix

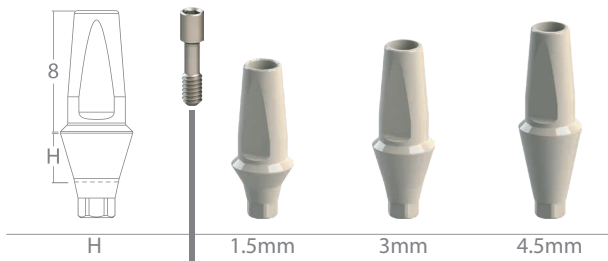

NobelActive™ Compatible*	PA-NA-NP15	PA-NA-NP30	PA-NA-NP45
Osstem® Hiossen® Compatible*	PA-TS-NP15	PA-TS-NP30	PA-TS-NP45
Astra Tech™TX Compatible*	PA-OS-SP15	PA-OS-SP30	PA-OS-SP45

PEEK - Anatomic Angled Abutment -15°
Narrow Platform

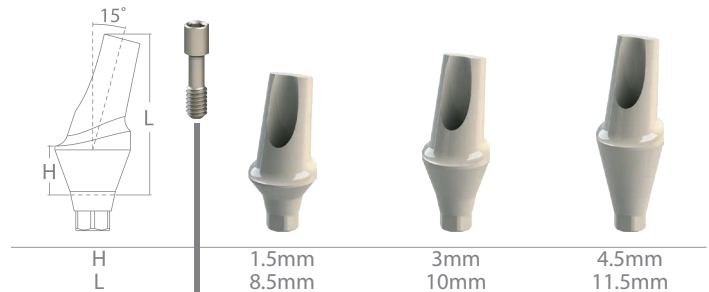

NobelActive™ Compatible*	PAA-NA-NP1515	PAA-NA-NP1530	PAA-NA-NP1545
Osstem® Hiossen® Compatible*	PAA-TS-NP1515	PAA-TS-NP1530	PAA-TS-NP1545
Astra Tech™TX Compatible*	PAA-OS-SP1515	PAA-OS-SP1530	PAA-OS-SP1545

* Registered trademarks are owned by their respective companies and there is no commercial relationship with Edison Medical. Its mention is made for proper identification purpose of the dental implants with which the Edison Medical abutments can be used.



Straight Titanium Abutment W/Shoulder
Regular Platform

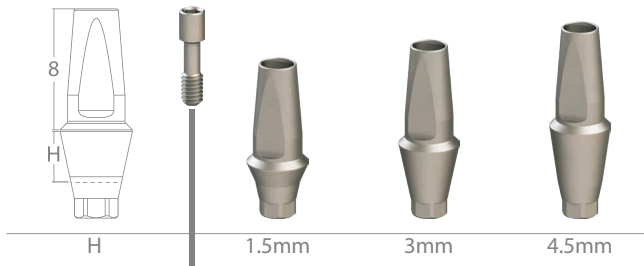

NobelActive™ Compatible*	TA-NA-RP15	TA-NA-RP30	TA-NA-RP45
Osstem® Hiossen® Compatible*	TA-TS-RP15	TA-TS-RP30	TA-TS-RP45
Dentium® Compatible*	TA-DE-RP15	TA-DE-RP30	TA-DE-RP45
MegaGen® AnyOne Compatible*	TA-AO-RP15	TA-AO-RP30	TA-AO-RP45
MegaGen® AnyRidge Compatible*	TA-AR-RP15	TA-AR-RP30	TA-AR-RP45
Astra Tech™TX Compatible*	TA-OS-WP15	TA-OS-WP30	TA-OS-WP45
Dio Implant® Compatible*	TA-UF-RP15	TA-UF-RP30	TA-UF-RP45
NeoBiotech® Compatible*	TA-IS-RP15	TA-IS-RP30	TA-IS-RP45

Anatomic Straight Titanium Abutment
Regular Platform

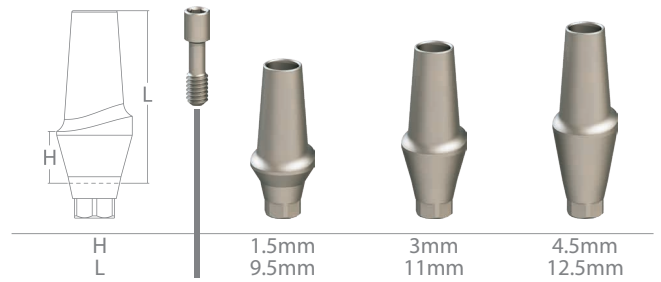

NobelActive™ Compatible*	TAA-NA-RP15	TAA-NA-RP30	TAA-NA-RP45
Osstem® Hiossen® Compatible*	TAA-TS-RP15	TAA-TS-RP30	TAA-TS-RP45
Dentium® Compatible*	TAA-DE-RP15	TAA-DE-RP30	TAA-DE-RP45
MegaGen® AnyOne Compatible*	TAA-AO-RP15	TAA-AO-RP30	TAA-AO-RP45
MegaGen® AnyRidge Compatible*	TAA-AR-RP15	TAA-AR-RP30	TAA-AR-RP45
Astra Tech™TX Compatible*	TAA-OS-WP15	TAA-OS-WP30	TAA-OS-WP45
Dio Implant® Compatible*	TAA-UF-RP15	TAA-UF-RP30	TAA-UF-RP45
NeoBiotech® Compatible*	TAA-IS-RP15	TAA-IS-RP30	TAA-IS-RP45

Straight Titanium Abutment W/Shoulder
Narrow Platform

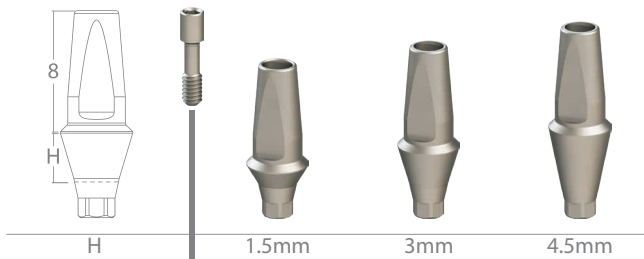

NobelActive™ Compatible*	TA-NA-NP15	TA-NA-NP30	TA-NA-NP45
Osstem® Hiossen® Compatible*	TA-TS-NP15	TA-TS-NP30	TA-TS-NP45
Astra Tech™TX Compatible*	TA-OS-SP15	TA-OS-SP30	TA-OS-SP45

Anatomic Straight Titanium Abutment
Narrow Platform

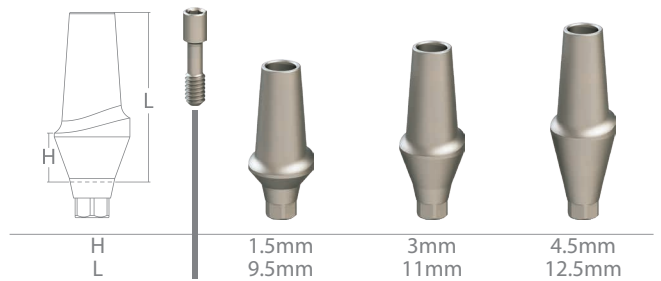

NobelActive™ Compatible*	TAA-NA-NP15	TAA-NA-NP30	TAA-NA-NP45
Osstem® Hiossen® Compatible*	TAA-TS-NP15	TAA-TS-NP30	TAA-TS-NP45
Astra Tech™TX Compatible*	TAA-OS-SP15	TAA-OS-SP30	TAA-OS-SP45

* Registered trademarks are owned by their respective companies and there is no commercial relationship with Edison Medical. Its mention is made for proper identification purpose of the dental implants with which the Edison Medical abutments can be used.



Standard Angled Abutment 15°
Regular Platform

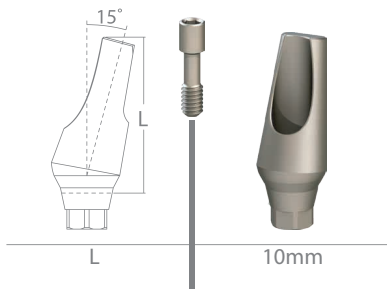

NobelActive™ Compatible*	TA-NA-RP1500
Osstem® Hiossen® Compatible*	TA-TS-RP1500
Dentium® Compatible*	TA-DE-RP1500
MegaGen® AnyOne Compatible*	TA-AO-RP1500
MegaGen® AnyRidge Compatible*	TA-AR-RP1500
Astra Tech™TX Compatible*	TA-OS-WP1500
Dio Implant® Compatible*	TA-UF-RP1500
NeoBiotech® Compatible*	TA-IS-RP1500

Anatomic Angled Abutment 15°
Regular Platform

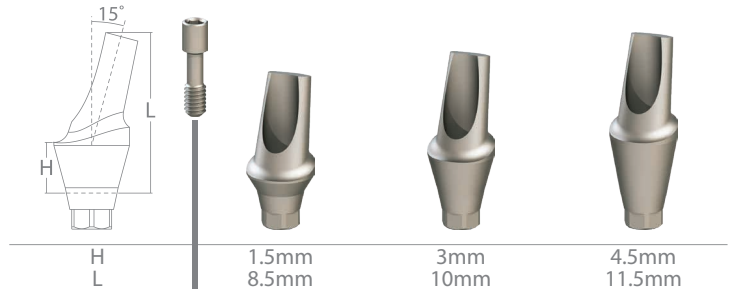

NobelActive™ Compatible*	TAA-NA-RP1515	TAA-NA-RP1530	TAA-NA-RP1545
Osstem® Hiossen® Compatible*	TAA-TS-RP1515	TAA-TS-RP1530	TAA-TS-RP1545
Dentium® Compatible*	TAA-DE-RP1515	TAA-DE-RP1530	TAA-DE-RP1545
MegaGen® AnyOne Compatible*	TAA-AO-RP1515	TAA-AO-RP1530	TAA-AO-RP1545
MegaGen® AnyRidge Compatible*	TAA-AR-RP1515	TAA-AR-RP1530	TAA-AR-RP1545
Astra Tech™TX Compatible*	TAA-OS-WP1515	TAA-OS-WP1530	TAA-OS-WP1545
Dio Implant® Compatible*	TAA-UF-RP1515	TAA-UF-RP1530	TAA-UF-RP1545
NeoBiotech® Compatible*	TAA-IS-RP1515	TAA-IS-RP1530	TAA-IS-RP1545

Standard Angled Abutment 15°
Narrow Platform

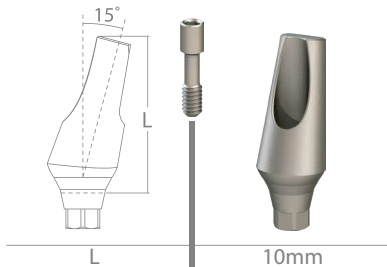

NobelActive™ Compatible*	TA-NA-NP1500
Osstem® Hiossen® Compatible*	TA-TS-NP1500
Astra Tech™TX Compatible*	TA-OS-SP1500

Anatomic Angled Abutment 15°
Narrow Platform

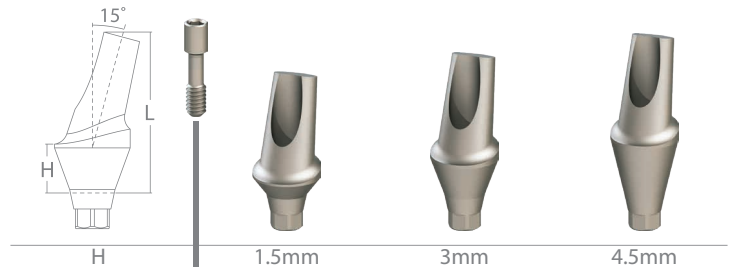

NobelActive™ Compatible*	TAA-NA-NP1515	TAA-NA-NP1530	TAA-NA-NP1545
Osstem® Hiossen® Compatible*	TAA-TS-NP1515	TAA-TS-NP1530	TAA-TS-NP1545
Astra Tech™TX Compatible*	TAA-OS-SP1515	TAA-OS-SP1530	TAA-OS-SP1545

* Registered trademarks are owned by their respective companies and there is no commercial relationship with Edison Medical. Its mention is made for proper identification purpose of the dental implants with which the Edison Medical abutments can be used.



Standard Angled Abutment 25°
Regular Platform

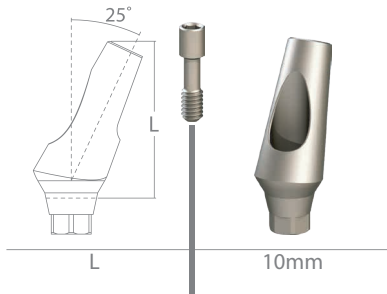

NobelActive™ Compatible*	TA-NA-RP2500
Osstem® Hiossen® Compatible*	TA-TS-RP2500
Dentium® Compatible*	TA-DE-RP2500
MegaGen® AnyOne Compatible*	TA-AO-RP2500
MegaGen® AnyRidge Compatible*	TA-AR-RP2500
Astra Tech™TX Compatible*	TA-OS-WP2500
Dio Implant® Compatible*	TA-UF-RP2500
NeoBiotech® Compatible*	TA-IS-RP2500

Anatomic Angled Abutment 25°
Regular Platform

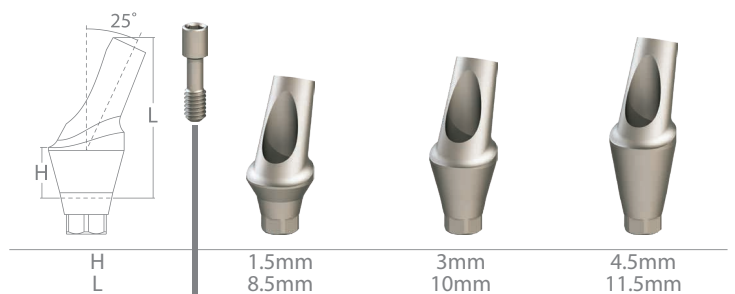

NobelActive™ Compatible*	TAA-NA-RP2515	TAA-NA-RP2530	TAA-NA-RP2545
Osstem® Hiossen® Compatible*	TAA-TS-RP2515	TAA-TS-RP2530	TAA-TS-RP2545
Dentium® Compatible*	TAA-DE-RP2515	TAA-DE-RP2530	TAA-DE-RP2545
MegaGen® AnyOne Compatible*	TAA-AO-RP2515	TAA-AO-RP2530	TAA-AO-RP2545
MegaGen® AnyRidge Compatible*	TAA-AR-RP2515	TAA-AR-RP2530	TAA-AR-RP2545
Astra Tech™TX Compatible*	TAA-OS-WP2515	TAA-OS-WP2530	TAA-OS-WP2545
Dio Implant® Compatible*	TAA-UF-RP2515	TAA-UF-RP2530	TAA-UF-RP2545
NeoBiotech® Compatible*	TAA-IS-RP2515	TAA-IS-RP2530	TAA-IS-RP2545

Standard Angled Abutment 25°
Narrow Platform

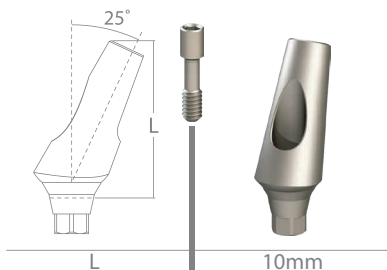

NobelActive™ Compatible*	TA-NA-NP2500
Osstem® Hiossen® Compatible*	TA-TS-NP2500
Astra Tech™TX Compatible*	TA-OS-SP2500

Anatomic Angled Abutment 25°
Narrow Platform

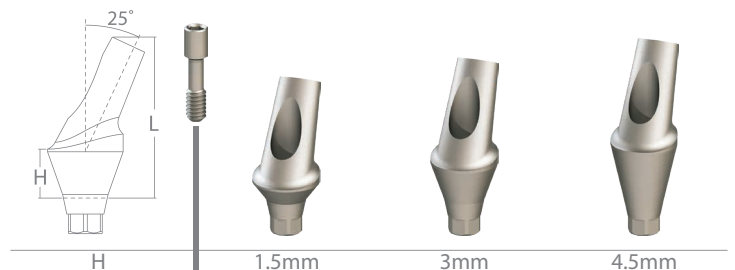

NobelActive™ Compatible*	TAA-NA-NP2515	TAA-NA-NP2530	TAA-NA-NP2545
Osstem® Hiossen® Compatible*	TAA-TS-NP2515	TAA-TS-NP2530	TAA-TS-NP2545
Astra Tech™TX Compatible*	TAA-OS-SP2515	TAA-OS-SP2530	TAA-OS-SP2545

* Registered trademarks are owned by their respective companies and there is no commercial relationship with Edison Medical. Its mention is made for proper identification purpose of the dental implants with which the Edison Medical abutments can be used.

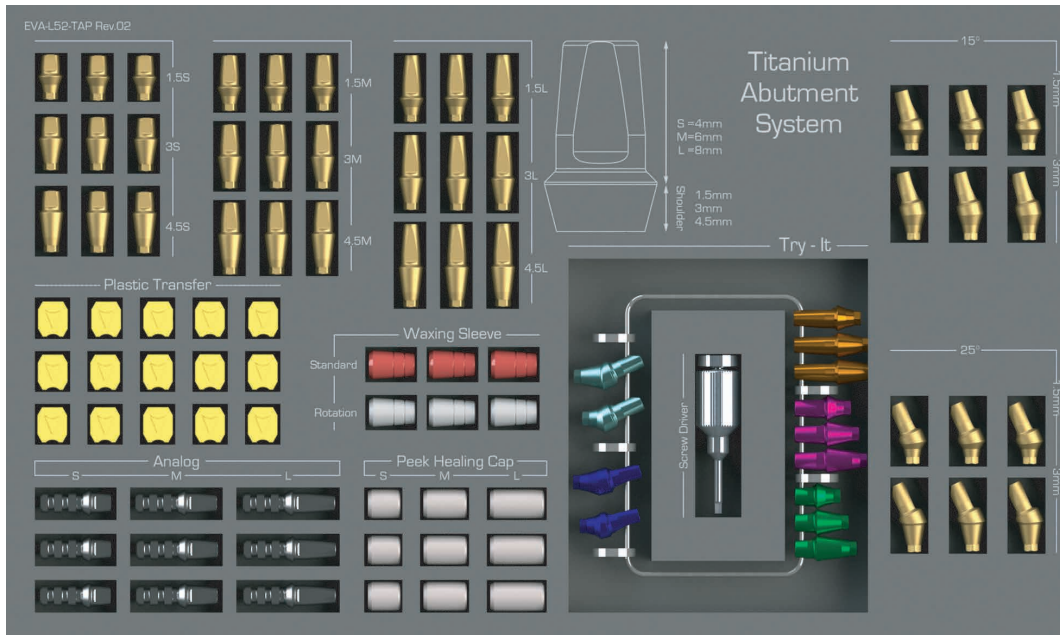

Professional Kit
Regular Platform

- NobelActive™ Compatible* | TAP-NA-RPPK
- Astra Tech™TX Compatible* | TAP-OS-WPPK
- Dio Implant® Compatible* | TAP-UF-RPPK
- NeoBiotech® Compatible* | TAP-IS-RPPK

- Osstem® Hiossen® Compatible* | TAP-TS-RPPK
- Dentium® Compatible* | TAP-DE-RPPK
- MegaGen® AnyOne® Compatible* | TAP-AO-RPPK

Professional Kit
Narrow Platform

- NobelActive™ Compatible* | TAP-NA-NPPK
- Osstem® Hiossen® Compatible* | TAP-TS-NPPK
- Astra Tech™TX Compatible* | TAP-OS-SPPK

Clicq™ Pression
Components

Abutment Analog



* Registered trademarks are owned by their respective companies and there is no commercial relationship with Edison Medical. Its mention is made for proper identification purpose of the dental implants with which the Edison Medical abutments can be used.

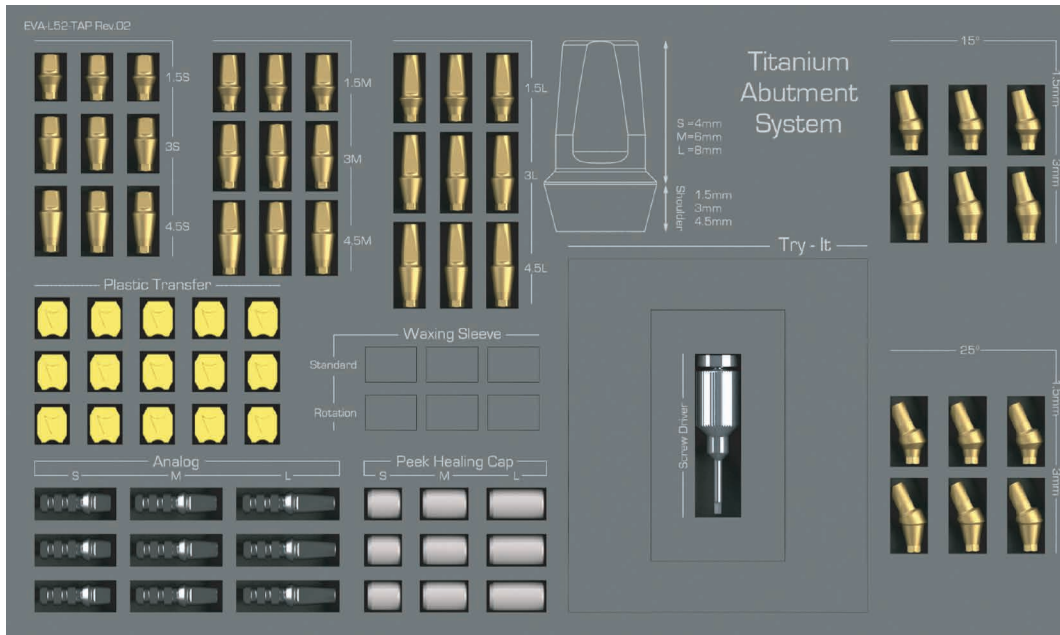

Starter Kit
Regular Platform

- NobelActive™ Compatible* | TAP-NA-RPSK
- Astra Tech™TX Compatible* | TAP-OS-WPSK
- Dio Implant® Compatible* | TAP-UF-RPSK
- NeoBiotech® Compatible* | TAP-IS-RPSK

- Osstem® Hiossen® Compatible* | TAP-TS-RPSK
- Dentium® Compatible* | TAP-DE-RPSK
- MegaGen® AnyOne® Compatible* | TAP-AO-RPSK

Starter Kit
Narrow Platform

- NobelActive™ Compatible* | TAP-NA-NPSK
- Osstem® Hiossen® Compatible* | TAP-TS-NPSK
- Astra Tech™TX Compatible* | TAP-OS-SPSK



* Registered trademarks are owned by their respective companies and there is no commercial relationship with Edison Medical. Its mention is made for proper identification purpose of the dental implants with which the Edison Medical abutments can be used.



Hexagon Straight Transfer Abutment - Short
Regular Platform



Contents:

- Straight / Angled Abutment
- Titanium Screw
- Plastic Transfer

Diagram	1.5mm	3mm	4.5mm
<p>H</p>			
	1.5mm	3mm	4.5mm
NobelActive™ Compatible *	TAP-NA-RP15S	TAP-NA-RP30S	TAP-NA-RP45S
Osstem® Hiossen® Compatible *	TAP-TS-RP15S	TAP-TS-RP30S	TAP-TS-RP45S
Dentium® Compatible *	TAP-DE-RP15S	TAP-DE-RP30S	TAP-DE-RP45S
MegaGen® AnyOne Compatible *	TAP-AO-RP15S	TAP-AO-RP30S	TAP-AO-RP45S
MegaGen® AnyRidge Compatible *	TAP-AR-RP15S	TAP-AR-RP30S	TAP-AR-RP45S
Astra Tech™TX Compatible *	TAP-OS-WP15S	TAP-OS-WP30S	TAP-OS-WP45S
Dio Implant® Compatible *	TAP-UF-RP15S	TAP-UF-RP30S	TAP-UF-RP45S
NeoBiotech® Compatible *	TAP-IS-RP15S	TAP-IS-RP30S	TAP-IS-RP45S



Hexagon Straight Titanium Transfer Abutment - Short
Narrow Platform

Diagram	1.5mm	3mm	4.5mm
<p>H</p>			
	1.5mm	3mm	4.5mm
NobelActive™ Compatible *	TAP-NA-NP15S	TAP-NA-NP30S	TAP-NA-NP45S
Osstem® Hiossen® Compatible *	TAP-TS-NP15S	TAP-TS-NP30S	TAP-TS-NP45S
Astra Tech™TX Compatible *	TAP-OS-SP15S	TAP-OS-SP30S	TAP-OS-SP45S

* Registered trademarks are owned by their respective companies and there is no commercial relationship with Edison Medical. Its mention is made for proper identification purpose of the dental implants with which the Edison Medical abutments can be used.



Straight Transfer Abutment - Medium
Regular Platform

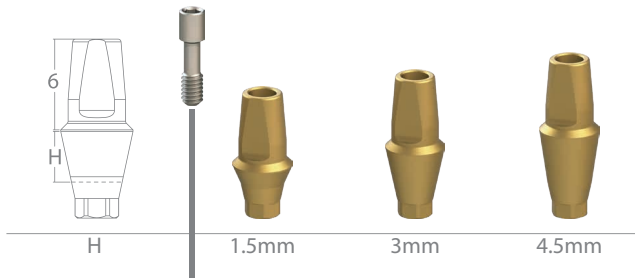

NobelActive™ Compatible*	TAP-NA-RP15M	TAP-NA-RP30M	TAP-NA-RP45M
Osstem® Hiossen® Compatible*	TAP-TS-RP15M	TAP-TS-RP30M	TAP-TS-RP45M
Dentium® Compatible*	TAP-DE-RP15M	TAP-DE-RP30M	TAP-DE-RP45M
MegaGen® AnyOne Compatible*	TAP-AO-RP15M	TAP-AO-RP30M	TAP-AO-RP45M
MegaGen® AnyRidge Compatible*	TAP-AR-RP15M	TAP-AR-RP30M	TAP-AR-RP45M
Astra Tech™TX Compatible*	TAP-OS-WP15M	TAP-OS-WP30M	TAP-OS-WP45M
Dio Implant® Compatible*	TAP-UF-RP15M	TAP-UF-RP30M	TAP-UF-RP45M
NeoBiotech® Compatible*	TAP-IS-RP15M	TAP-IS-RP30M	TAP-IS-RP45M

Straight Transfer Abutment - Long
Regular Platform

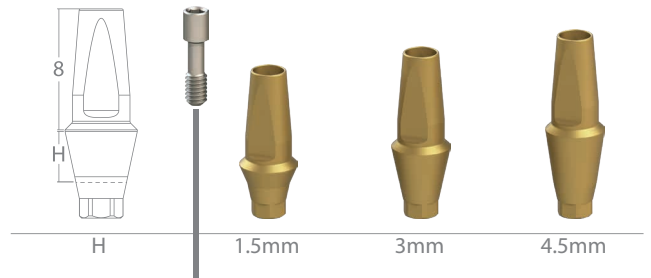

NobelActive™ Compatible*	TAP-NA-RP15L	TAP-NA-RP30L	TAP-NA-RP45L
Osstem® Hiossen® Compatible*	TAP-TS-RP15L	TAP-TS-RP30L	TAP-TS-RP45L
Dentium® Compatible*	TAP-DE-RP15L	TAP-DE-RP30L	TAP-DE-RP45L
MegaGen® AnyOne Compatible*	TAP-AO-RP15L	TAP-AO-RP30L	TAP-AO-RP45L
MegaGen® AnyRidge Compatible*	TAP-AR-RP15L	TAP-AR-RP30L	TAP-AR-RP45L
Astra Tech™TX Compatible*	TAP-OS-WP15L	TAP-OS-WP30L	TAP-OS-WP45L
Dio Implant® Compatible*	TAP-UF-RP15L	TAP-UF-RP30L	TAP-UF-RP45L
NeoBiotech® Compatible*	TAP-IS-RP15L	TAP-IS-RP30L	TAP-IS-RP45L

Straight Transfer Abutment - Medium
Narrow Platform

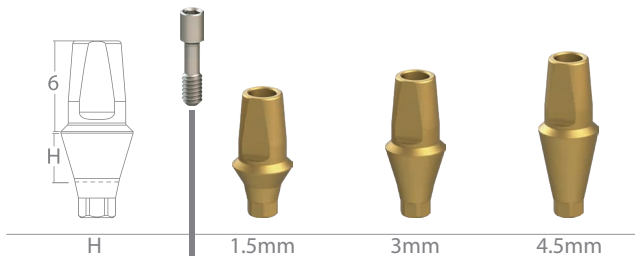

NobelActive™ Compatible*	TAP-NA-NP15M	TAP-NA-NP30M	TAP-NA-NP45M
Osstem® Hiossen® Compatible*	TAP-TS-NP15M	TAP-TS-NP30M	TAP-TS-NP45M
Astra Tech™TX Compatible*	TAP-OS-SP15M	TAP-OS-SP30M	TAP-OS-SP45M

Straight Transfer Abutment - Long
Narrow Platform

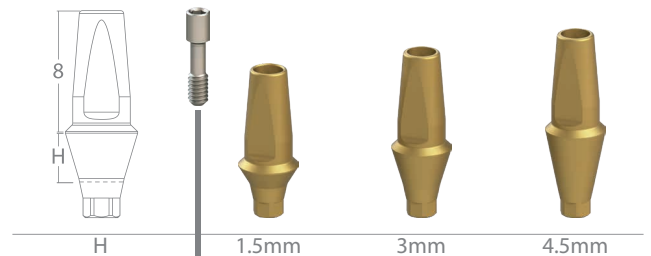

NobelActive™ Compatible*	TAP-NA-NP15L	TAP-NA-NP30L	TAP-NA-NP45L
Osstem® Hiossen® Compatible*	TAP-TS-NP15L	TAP-TS-NP30L	TAP-TS-NP45L
Astra Tech™TX Compatible*	TAP-OS-SP15L	TAP-OS-SP30L	TAP-OS-SP45L

* Registered trademarks are owned by their respective companies and there is no commercial relationship with Edison Medical. Its mention is made for proper identification purpose of the dental implants with which the Edison Medical abutments can be used.



Angled Transfer Abutment - 15°
Regular Platform

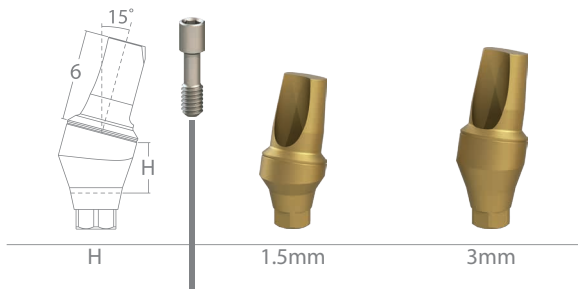

NobelActive™ Compatible*	TAP-NA-RP1515	TAP-NA-RP1530
Osstem® Hiossen® Compatible*	TAP-TS-RP1515	TAP-TS-RP1530
Dentium® Compatible*	TAP-DE-RP1515	TAP-DE-RP1530
MegaGen® AnyOne Compatible*	TAP-AO-RP1515	TAP-AO-RP1530
MegaGen® AnyRidge Compatible*	TAP-AR-RP1515	TAP-AR-RP1530
Astra Tech™TX Compatible*	TAP-OS-WP1515	TAP-OS-WP1530
Dio Implant® Compatible*	TAP-UF-RP1515	TAP-UF-RP1530
NeoBiotech® Compatible*	TAP-IS-RP1515	TAP-IS-RP1530

Angled Transfer Abutment - 25°
Regular Platform

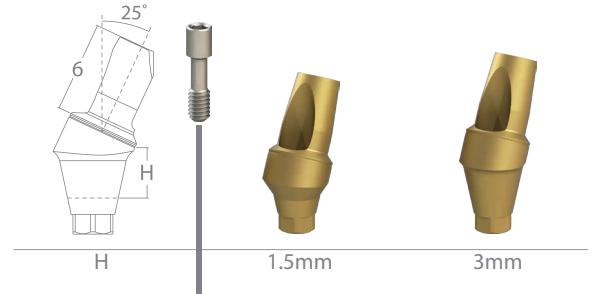

NobelActive™ Compatible*	TAP-NA-RP2515	TAP-NA-RP2530
Osstem® Hiossen® Compatible*	TAP-TS-RP2515	TAP-TS-RP2530
Dentium® Compatible*	TAP-DE-RP2515	TAP-DE-RP2530
MegaGen® AnyOne Compatible*	TAP-AO-RP2515	TAP-AO-RP2530
MegaGen® AnyRidge Compatible*	TAP-AR-RP2515	TAP-AR-RP2530
Astra Tech™TX Compatible*	TAP-OS-WP2515	TAP-OS-WP2530
Dio Implant® Compatible*	TAP-UF-RP2515	TAP-UF-RP2530
NeoBiotech® Compatible*	TAP-IS-RP2515	TAP-IS-RP2530



Angled Transfer Abutment - 15°
Narrow Platform

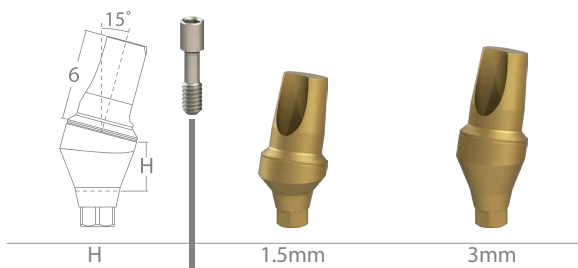

NobelActive™ Compatible*	TAP-NA-NP1515	TAP-NA-NP1530
Osstem® Hiossen® Compatible*	TAP-TS-NP1515	TAP-TS-NP1530
Astra Tech™TX Compatible*	TAP-OS-SP1515	TAP-OS-SP1530

Angled Transfer Abutment - 25°
Narrow Platform

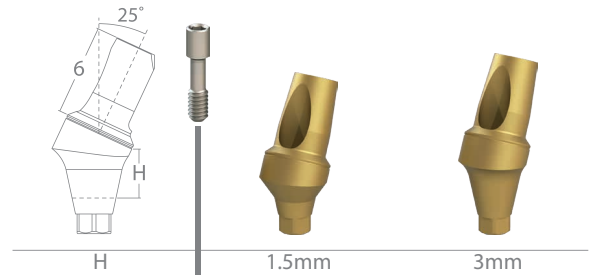

NobelActive™ Compatible*	TAP-NA-NP2515	TAP-NA-NP2530
Osstem® Hiossen® Compatible*	TAP-TS-NP2515	TAP-TS-NP2530
Astra Tech™TX Compatible*	TAP-OS-SP2515	TAP-OS-SP2530

* Registered trademarks are owned by their respective companies and there is no commercial relationship with Edison Medical. Its mention is made for proper identification purpose of the dental implants with which the Edison Medical abutments can be used.

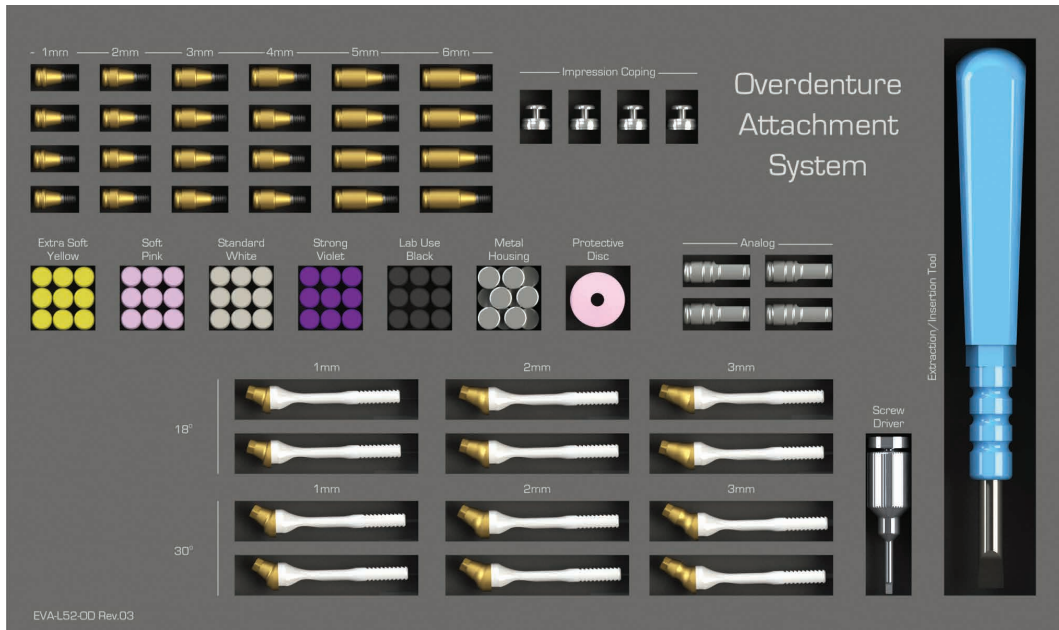

EVA-L52-00 Rev.03

Professional Kit
Regular Platform

- NobelActive™ Compatible* | LOCW-NA-RPPK
- Astra Tech™TX Compatible* | LOCW-OS-WPPK
- Dio Implant® Compatible* | LOCW-UF-RPPK
- NeoBiotech® Compatible* | LOCW-IS-RPPK

- Osstem® Hiossen® Compatible* | LOCW-TS-RPPK
- Dentium® Compatible* | LOCW-DE-RPPK
- MegaGen® AnyOne Compatible* | LOCW-AO-RPPK



Professional Kit
Narrow Platform

- NobelActive™ Compatible* | LOCW-NA-NPPK
- Osstem® Hiossen® Compatible* | LOCW-TS-NPPK
- Astra Tech™TX Compatible* | LOCW-OS-SPPK

Pop Clicq™ - Components

Retentive Cap

- LOCW-RCV Violet 2.7kg (4 pcs.)
- LOCW-RCT Transparent 1.8kg (4 pcs.)
- LOCW-RCP Pink 1.2kg (4 pcs.)
- LOCW-RCY Yellow 0.6kg (4 pcs.)
- LOCW-RCB Black laboratory (4 pcs.)

Metal Housing



Pick-Up Impression Transfer Assembled with Yellow Retentive Cap



Analog for Abutment



Protective Disc



Overdenture Tool KIT for Insertion & Extraction of Retentive Caps Suitable for all Overdenture lines

* Registered trademarks are owned by their respective companies and there is no commercial relationship with Edison Medical. Its mention is made for proper identification purpose of the dental implants with which the Edison Medical abutments can be used.



Starter Kit
Regular Platform

- NobelActive™
Compatible* | LOCW-NA-RPSK
- Astra Tech™TX
Compatible* | LOCW-OS-WPSK
- Dio Implant®
Compatible* | LOCW-UF-RPSK
- NeoBiotech®
Compatible* | LOCW-IS-RPSK

- Osstem®
Hiossen®
Compatible* | LOCW-TS-RPSK
- Dentium®
Compatible* | LOCW-DE-RPSK
- MegaGen®
AnyOne
Compatible* | LOCW-AO-RPSK

Starter Kit
Narrow Platform

- NobelActive™
Compatible* | LOCW-NA-NPSK
- Osstem®
Hiossen®
Compatible* | LOCW-TS-NPSK
- Astra Tech™TX
Compatible* | LOCW-OS-SPSK



* Registered trademarks are owned by their respective companies and there is no commercial relationship with Edison Medical. Its mention is made for proper identification purpose of the dental implants with which the Edison Medical abutments can be used.



○ Straight Titanium Pop-Clicq™ - Mini Kit
Regular Platform

H	1mm	2mm	3mm	4mm	5mm	6mm
NobelActive™ Compatible*	LOCW-NA-RP10K	LOCW-NA-RP20K	LOCW-NA-RP30K	LOCW-NA-RP40K	LOCW-NA-RP50K	LOCW-NA-RP60K
Osstem® Hiossen® Compatible*	LOCW-TS-RP10K	LOCW-TS-RP20K	LOCW-TS-RP30K	LOCW-TS-RP40K	LOCW-TS-RP50K	LOCW-TS-RP60K
Dentium® Compatible*	LOCW-DE-RP10K	LOCW-DE-RP20K	LOCW-DE-RP30K	LOCW-DE-RP40K	LOCW-DE-RP50K	LOCW-DE-RP60K
MegaGen® AnyOne Compatible*	LOCW-AO-RP10K	LOCW-AO-RP20K	LOCW-AO-RP30K	LOCW-AO-RP40K	LOCW-AO-RP50K	LOCW-AO-RP60K
MegaGen® AnyRidge Compatible*	LOCW-AR-RP10K	LOCW-AR-RP20K	LOCW-AR-RP30K	LOCW-AR-RP40K	LOCW-AR-RP50K	LOCW-AR-RP60K
Astra Tech™TX Compatible*	LOCW-OS-WP10K	LOCW-OS-WP20K	LOCW-OS-WP30K	LOCW-OS-WP40K	LOCW-OS-WP50K	LOCW-OS-WP60K
Dio Implant® Compatible*	LOCW-UF-RP10K	LOCW-UF-RP20K	LOCW-UF-RP30K	LOCW-UF-RP40K	LOCW-UF-RP50K	LOCW-UF-RP60K
NeoBiotech® Compatible*	LOCW-IS-RP10K	LOCW-IS-RP20K	LOCW-IS-RP30K	LOCW-IS-RP40K	LOCW-IS-RP50K	LOCW-IS-RP60K



Pop Clicq™
Straight Mini Kit



○ Straight Titanium Pop-Clicq™ - Mini Kit
Narrow Platform

H	1mm	2mm	3mm	4mm	5mm	6mm
NobelActive™ Compatible*	LOCW-NA-NP10K	LOCW-NA-NP20K	LOCW-NA-NP30K	LOCW-NA-NP40K	LOCW-NA-NP50K	LOCW-NA-NP60K
Osstem® Hiossen® Compatible*	LOCW-TS-NP10K	LOCW-TS-NP20K	LOCW-TS-NP30K	LOCW-TS-NP40K	LOCW-TS-NP50K	LOCW-TS-NP60K
Astra Tech™TX Compatible*	LOCW-OS-SP10K	LOCW-OS-SP20K	LOCW-OS-SP30K	LOCW-OS-SP40K	LOCW-OS-SP50K	LOCW-OS-SP60K

* Registered trademarks are owned by their respective companies and there is no commercial relationship with Edison Medical. Its mention is made for proper identification purpose of the dental implants with which the Edison Medical abutments can be used.



Angled Titanium Pop-Clicq™ - Mini Kit - 18°
Regular Platform

H	1mm	2mm	3mm
			
NobelActive™ Compatible*	LOCW-NA-RP1810K	LOCW-NA-RP1820K	LOCW-NA-RP1830K
Osstem® Hiossen® Compatible*	LOCW-TS-RP1810K	LOCW-TS-RP1820K	LOCW-TS-RP1830K
Dentium® Compatible*	LOCW-DE-RP1810K	LOCW-DE-RP1820K	LOCW-DE-RP1830K
MegaGen® AnyOne Compatible*	LOCW-AO-RP1810K	LOCW-AO-RP1820K	LOCW-AO-RP1830K
MegaGen® AnyRidge Compatible*	LOCW-AR-RP1810K	LOCW-AR-RP1820K	LOCW-AR-RP1830K
Astra Tech™TX Compatible*	LOCW-OS-WP1810K	LOCW-OS-WP1820K	LOCW-OS-WP1830K
Dio Implant® Compatible*	LOCW-UF-RP1810K	LOCW-UF-RP1820K	LOCW-UF-RP1830K
NeoBiotech® Compatible*	LOCW-IS-RP1810K	LOCW-IS-RP1820K	LOCW-IS-RP1830K



Pop Clicq™
Angled Mini Kit

Angled Titanium Pop-Clicq™ - Mini Kit - 18°
Narrow Platform

H	1mm	2mm	3mm
			
NobelActive™ Compatible*	LOCW-NA-NP1810K	LOCW-NA-NP1820K	LOCW-NA-NP1830K
Osstem® Hiossen® Compatible*	LOCW-TS-NP1810K	LOCW-TS-NP1820K	LOCW-TS-NP1830K
Astra Tech™TX Compatible*	LOCW-OS-SP1810K	LOCW-OS-SP1820K	LOCW-OS-SP1830K



* Registered trademarks are owned by their respective companies and there is no commercial relationship with Edison Medical. Its mention is made for proper identification purpose of the dental implants with which the Edison Medical abutments can be used.



Angled Titanium Pop-Clicq™ - Mini Kit - 30°
Regular Platform

Diagram	1mm	2mm	3mm
<p>H</p>			
NobelActive™ Compatible*	LOCW-NA-RP3010K	LOCW-NA-RP3020K	LOCW-NA-RP3030K
Osstem® Hiossen® Compatible*	LOCW-TS-RP3010K	LOCW-TS-RP3020K	LOCW-TS-RP3030K
Dentium® Compatible*	LOCW-DE-RP3010K	LOCW-DE-RP3020K	LOCW-DE-RP3030K
MegaGen® AnyOne Compatible*	LOCW-AO-RP3010K	LOCW-AO-RP3020K	LOCW-AO-RP3030K
MegaGen® AnyRidge Compatible*	LOCW-AR-RP3010K	LOCW-AR-RP3020K	LOCW-AR-RP3030K
Astra Tech™TX Compatible*	LOCW-OS-WP3010K	LOCW-OS-WP3020K	LOCW-OS-WP3030K
Dio Implant® Compatible*	LOCW-UF-RP3010K	LOCW-UF-RP3020K	LOCW-UF-RP3030K
NeoBiotech® Compatible*	LOCW-IS-RP3010K	LOCW-IS-RP3020K	LOCW-IS-RP3030K



Pop Clicq™
Angled Mini Kit

Angled Titanium Pop-Clicq™ - Mini Kit - 30°
Narrow Platform

Diagram	1mm	2mm	3mm
<p>H</p>			
NobelActive™ Compatible*	LOCW-NA-NP3010K	LOCW-NA-NP3020K	LOCW-NA-NP3030K
Osstem® Hiossen® Compatible*	LOCW-TS-NP3010K	LOCW-TS-NP3020K	LOCW-TS-NP3030K
Astra Tech™TX Compatible*	LOCW-OS-SP3010K	LOCW-OS-SP3020K	LOCW-OS-SP3030K

* Registered trademarks are owned by their respective companies and there is no commercial relationship with Edison Medical. Its mention is made for proper identification purpose of the dental implants with which the Edison Medical abutments can be used.

Pop Clicq™ - Bar



Design Patent Pending No. 62154



Get a permanent bar for your patient
within minutes

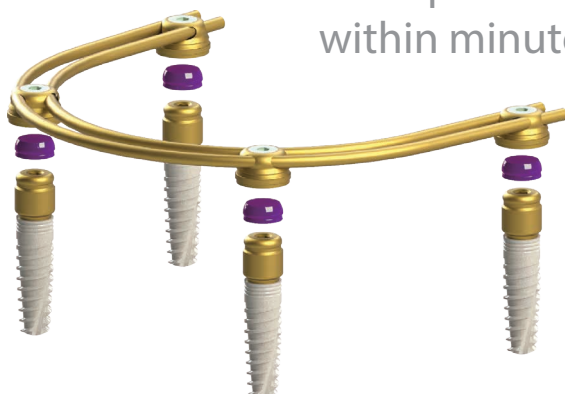

Compatible with:

 Conical Connection

 Internal Hex



Kits REF (Type A)

LOCW-BK2

LOCW-BK2D (Screw Driver Included)

Kits REF (Type B)

LOCW-BK4

LOCW-BK4D (Screw Driver Included)

Pop Clicq™ - Bar Components

 Bars *2

 (A) Adjustable Metal Housing *2
(B) Adjustable Metal Housing *4
(With a fixed screw)

 Pop Clicq™ Bar
(A) Metal Housing Tool \ Adapter *2
(B) Metal Housing Tool \ Adapter *4



(A) Analog for Pop Clicq™ Abutment *2
(B) Analog for Pop Clicq™ Abutment *4



(A) Pick-Up Impression Transfer *2
(B) Pick-Up Impression Transfer *4



Adjusting Screws for
(A) Metal Housing *3 (Incl. spares)
(B) Metal Housing *6 (Incl. spares)

* Registered trademarks are owned by their respective companies and there is no commercial relationship with Edison Medical. Its mention is made for proper identification purpose of the dental implants with which the Edison Medical abutments can be used.

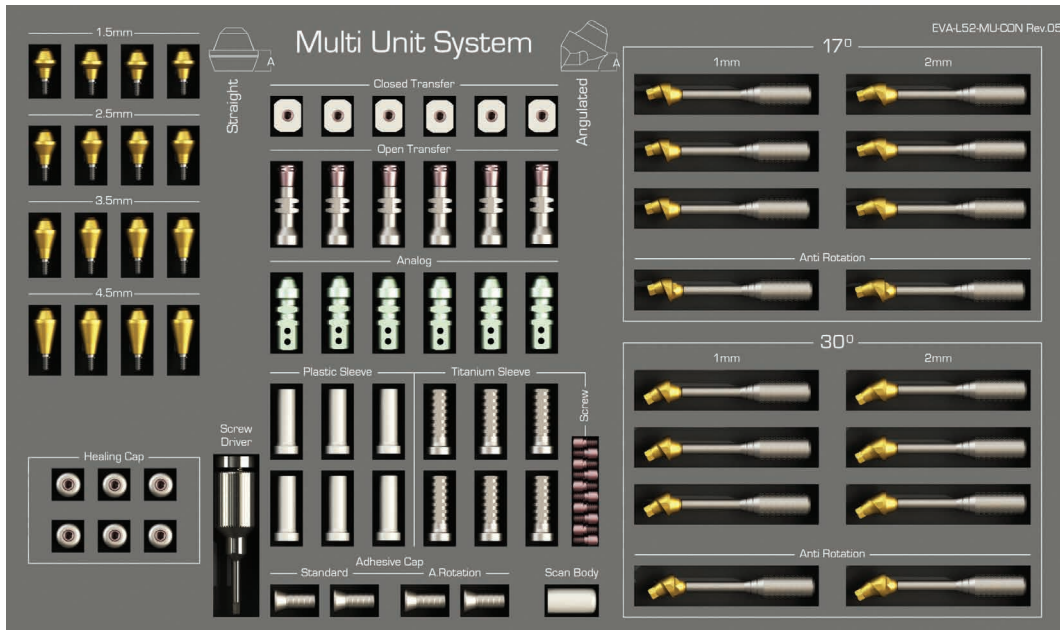

Professional Kit
Regular Platform

- NobelActive™
Compatible* | MUL-NA-RPPK
- Astra Tech™TX
Compatible* | MUL-OS-WPPK
- Dio Implant®
Compatible* | MUL-UF-RPPK
- NeoBiotech®
Compatible* | MUL-IS-RPPK

- Osstem®
Hiossen®
Compatible* | MUL-TS-RPPK
- Dentium®
Compatible* | MUL-DE-RPPK
- MegaGen®
AnyOne
Compatible* | MUL-AO-RPPK

Professional Kit
Narrow Platform

- NobelActive™
Compatible* | MUL-NA-NPPK
- Osstem®
Hiossen®
Compatible* | MUL-TS-NPPK
- Astra Tech™TX
Compatible* | MUL-OS-SPPK



* Registered trademarks are owned by their respective companies and there is no commercial relationship with Edison Medical. Its mention is made for proper identification purpose of the dental implants with which the Edison Medical abutments can be used.

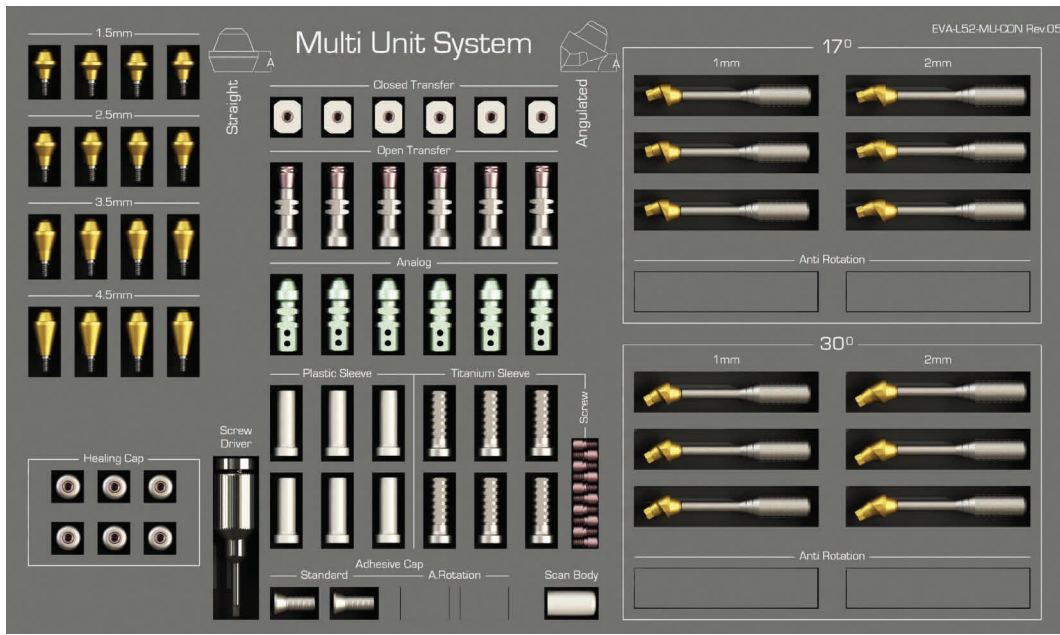

Starter Kit
Regular Platform

NobelActive™ Compatible*	MUL-NA-RPSK
Astra Tech™TX Compatible*	MUL-OS-WPSK
Dio Implant® Compatible*	MUL-UF-RPSK
NeoBiotech® Compatible*	MUL-IS-RPSK

Osstem® Hiossen® Compatible*	MUL-TS-RPSK
Dentium® Compatible*	MUL-DE-RPSK
MegaGen® AnyOne Compatible*	MUL-AO-RPSK

Starter Kit
Narrow Platform

NobelActive™ Compatible*	MUL-NA-NPSK
Osstem® Hiossen® Compatible*	MUL-TS-NPSK
Astra Tech™TX Compatible*	MUL-OS-SPSK



Optional:
* Rotational Adhesive cap
* Anti-Rotational Adhesive cap

* Registered trademarks are owned by their respective companies and there is no commercial relationship with Edison Medical. Its mention is made for proper identification purpose of the dental implants with which the Edison Medical abutments can be used.



Abutment Analog



Closed Tray Plastic Transfer



Castable Plastic Sleeve



Cobalt Sleeve UCLA



Open Tray Transfer



Healing cap



Scan Body (Peek)

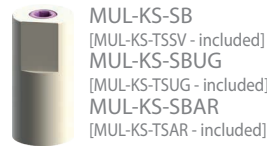

Temporary Titanium Sleeve



Rotational Titanium Base

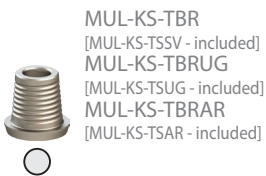

Anti Rotational Titanium Base



Rotational Adhesive Cap



Anti Rotational Adhesive Cap



Prosthetic Titanium Screw



* Registered trademarks are owned by their respective companies and there is no commercial relationship with Edison Medical. Its mention is made for proper identification purpose of the dental implants with which the Edison Medical abutments can be used.

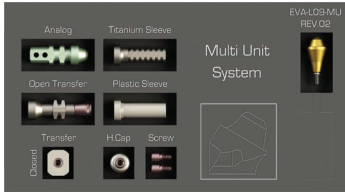

Straight Mini Kit
Regular Platform



H	1.5mm	2.5mm	3.5mm	4.5mm	5.5mm
NobelActive™ Compatible*	MUL-NA-RPKS15K	MUL-NA-RPKS25K	MUL-NA-RPKS35K	MUL-NA-RPKS45K	MUL-NA-RPKS55K
Osstem® Hiossen® Compatible*	MUL-TS-RPKS15K	MUL-TS-RPKS25K	MUL-TS-RPKS35K	MUL-TS-RPKS45K	MUL-TS-RPKS55K
Dentium® Compatible*	MUL-DE-RPKS15K	MUL-DE-RPKS25K	MUL-DE-RPKS35K	MUL-DE-RPKS45K	MUL-DE-RPKS55K
MegaGen® AnyOne Compatible*	MUL-AO-RPKS15K	MUL-AO-RPKS25K	MUL-AO-RPKS35K	MUL-AO-RPKS45K	MUL-AO-RPKS55K
MegaGen® AnyRidge Compatible*	MUL-AR-RPKS15K	MUL-AR-RPKS25K	MUL-AR-RPKS35K	MUL-AR-RPKS45K	MUL-AR-RPKS55K
Astra Tech™TX Compatible*	MUL-OS-WPKS15K	MUL-OS-WPKS25K	MUL-OS-WPKS35K	MUL-OS-WPKS45K	MUL-OS-WPKS55K
Dio Implant® Compatible*	MUL-UF-RPKS15K	MUL-UF-RPKS25K	MUL-UF-RPKS35K	MUL-UF-RPKS45K	MUL-UF-RPKS55K
NeoBiotech® Compatible*	MUL-IS-RPKS15K	MUL-IS-RPKS25K	MUL-IS-RPKS35K	MUL-IS-RPKS45K	MUL-IS-RPKS55K

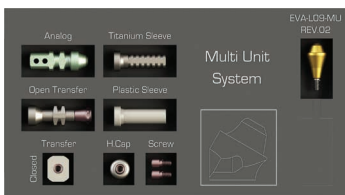

Straight Mini Kit
Narrow Platform



H	1.5mm	2.5mm	3.5mm	4.5mm	5.5mm
NobelActive™ Compatible*	MUL-NA-NPKS15K	MUL-NA-NPKS25K	MUL-NA-NPKS35K	MUL-NA-NPKS45K	MUL-NA-NPKS55K
Osstem® Hiossen® Compatible*	MUL-TS-NPKS15K	MUL-TS-NPKS25K	MUL-TS-NPKS35K	MUL-TS-NPKS45K	MUL-TS-NPKS55K
Astra Tech™TX Compatible*	MUL-OS-SPKS15K	MUL-OS-SPKS25K	MUL-OS-SPKS35K	MUL-OS-SPKS45K	MUL-OS-SPKS55K

* Registered trademarks are owned by their respective companies and there is no commercial relationship with Edison Medical. Its mention is made for proper identification purpose of the dental implants with which the Edison Medical abutments can be used.

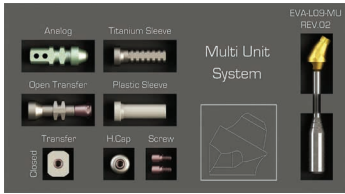

One Piece Angled 17°
Abutment Mini Kit
Regular Platform



H G	1mm 2.5mm	2mm 3.5mm
NobelActive™ Compatible*	MUL-NA-RPKS1710K	MUL-NA-RPKS1720K
Osstem® Hiossen® Compatible*	MUL-TS-RPKS1710K	MUL-TS-RPKS1720K
Dentium® Compatible*	MUL-DE-RPKS1710K	MUL-DE-RPKS1720K
MegaGen® AnyOne Compatible*	MUL-AO-RPKS1710K	MUL-AO-RPKS1720K
MegaGen® AnyRidge Compatible*	MUL-AR-RPKS1710K	MUL-AR-RPKS1720K
Astra Tech™TX Compatible*	MUL-OS-WPKS1710K	MUL-OS-WPKS1720K
Dio Implant® Compatible*	MUL-UF-RPKS1710K	MUL-UF-RPKS1720K
NeoBiotech® Compatible*	MUL-IS-RPKS1710K	MUL-IS-RPKS1720K

One Piece Angled 30°
Abutment Mini Kit
Regular Platform



H G	1mm 3.5mm	2mm 4.5mm
NobelActive™ Compatible*	MUL-NA-RPKS3010K	MUL-NA-RPKS3020K
Osstem® Hiossen® Compatible*	MUL-TS-RPKS3010K	MUL-TS-RPKS3020K
Dentium® Compatible*	MUL-DE-RPKS3010K	MUL-DE-RPKS3020K
MegaGen® AnyOne Compatible*	MUL-AO-RPKS3010K	MUL-AO-RPKS3020K
MegaGen® AnyRidge Compatible*	MUL-AR-RPKS3010K	MUL-AR-RPKS3020K
Astra Tech™TX Compatible*	MUL-OS-WPKS3010K	MUL-OS-WPKS3020K
Dio Implant® Compatible*	MUL-UF-RPKS3010K	MUL-UF-RPKS3020K
NeoBiotech® Compatible*	MUL-IS-RPKS3010K	MUL-IS-RPKS3020K

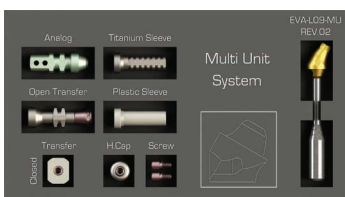

One Piece Angled 17°
Abutment Mini Kit
Narrow Platform



H G	1mm 2.5mm	2mm 3.5mm
NobelActive™ Compatible*	MUL-NA-NPKS1710K	MUL-NA-NPKS1720K
Osstem® Hiossen® Compatible*	MUL-TS-NPKS1710K	MUL-TS-NPKS1720K
Astra Tech™TX Compatible*	MUL-OS-SPKS1710K	MUL-OS-SPKS1720K

One Piece Angled 30°
Abutment Mini Kit
Narrow Platform



H G	1mm 3.5mm	2mm 4.5mm
NobelActive™ Compatible*	MUL-NA-NPKS3010K	MUL-NA-NPKS3020K
Osstem® Hiossen® Compatible*	MUL-TS-NPKS3010K	MUL-TS-NPKS3020K
Astra Tech™TX Compatible*	MUL-OS-SPKS3010K	MUL-OS-SPKS3020K

* Registered trademarks are owned by their respective companies and there is no commercial relationship with Edison Medical. Its mention is made for proper identification purpose of the dental implants with which the Edison Medical abutments can be used.



Straight Abutment
Regular Platform

H	1.5mm	2.5mm	3.5mm	4.5mm	5.5mm
					
NobelActive™ Compatible*	MUL-NA-RPKS15	MUL-NA-RPKS25	MUL-NA-RPKS35	MUL-NA-RPKS45	MUL-NA-RPKS55
Osstem® Hiossen® Compatible*	MUL-TS-RPKS15	MUL-TS-RPKS25	MUL-TS-RPKS35	MUL-TS-RPKS45	MUL-TS-RPKS55
Dentium® Compatible*	MUL-DE-RPKS15	MUL-DE-RPKS25	MUL-DE-RPKS35	MUL-DE-RPKS45	MUL-DE-RPKS55
MegaGen® AnyOne Compatible*	MUL-AO-RPKS15	MUL-AO-RPKS25	MUL-AO-RPKS35	MUL-AO-RPKS45	MUL-AO-RPKS55
MegaGen® AnyRidge Compatible*	MUL-AR-RPKS15	MUL-AR-RPKS25	MUL-AR-RPKS35	MUL-AR-RPKS45	MUL-AR-RPKS55
Astra Tech™TX Compatible*	MUL-OS-WPKS15	MUL-OS-WPKS25	MUL-OS-WPKS35	MUL-OS-WPKS45	MUL-OS-WPKS55
Dio Implant® Compatible*	MUL-UF-RPKS15	MUL-UF-RPKS25	MUL-UF-RPKS35	MUL-UF-RPKS45	MUL-UF-RPKS55
NeoBiotech® Compatible*	MUL-IS-RPKS15	MUL-IS-RPKS25	MUL-IS-RPKS35	MUL-IS-RPKS45	MUL-IS-RPKS55

Straight Abutment
Narrow Platform

H	1.5mm	2.5mm	3.5mm	4.5mm	5.5mm
					
NobelActive™ Compatible*	MUL-NA-NPKS15	MUL-NA-NPKS25	MUL-NA-NPKS35	MUL-NA-NPKS45	MUL-NA-NPKS55
Osstem® Hiossen® Compatible*	MUL-TS-NPKS15	MUL-TS-NPKS25	MUL-TS-NPKS35	MUL-TS-NPKS45	MUL-TS-NPKS55
Astra Tech™TX Compatible*	MUL-OS-SPKS15	MUL-OS-SPKS25	MUL-OS-SPKS35	MUL-OS-SPKS45	MUL-OS-SPKS55

* Registered trademarks are owned by their respective companies and there is no commercial relationship with Edison Medical. Its mention is made for proper identification purpose of the dental implants with which the Edison Medical abutments can be used.



One Piece Angled Abutment - 17°
Regular Platform

	1mm 2.5mm	2mm 3.5mm
NobelActive™ Compatible*	MUL-NA-RPKS1710	MUL-NA-RPKS1720
Osstem® Hiossen® Compatible*	MUL-TS-RPKS1710	MUL-TS-RPKS1720
Dentium® Compatible*	MUL-DE-RPKS1710	MUL-DE-RPKS1720
MegaGen® AnyOne Compatible*	MUL-AO-RPKS1710	MUL-AO-RPKS1720
MegaGen® AnyRidge Compatible*	MUL-AR-RPKS1710	MUL-AR-RPKS1720
Astra Tech™TX Compatible*	MUL-OS-WPKS1710	MUL-OS-WPKS1720
Dio Implant® Compatible*	MUL-UF-RPKS1710	MUL-UF-RPKS1720
NeoBiotech® Compatible*	MUL-IS-RPKS1710	MUL-IS-RPKS1720

One Piece Angled Abutment - 30°
Regular Platform

	1mm 3.5mm	2mm 4.5mm
NobelActive™ Compatible*	MUL-NA-RPKS3010	MUL-NA-RPKS3020
Osstem® Hiossen® Compatible*	MUL-TS-RPKS3010	MUL-TS-RPKS3020
Dentium® Compatible*	MUL-DE-RPKS3010	MUL-DE-RPKS3020
MegaGen® AnyOne Compatible*	MUL-AO-RPKS3010	MUL-AO-RPKS3020
MegaGen® AnyRidge Compatible*	MUL-AR-RPKS3010	MUL-AR-RPKS3020
Astra Tech™TX Compatible*	MUL-OS-WPKS3010	MUL-OS-WPKS3020
Dio Implant® Compatible*	MUL-UF-RPKS3010	MUL-UF-RPKS3020
NeoBiotech® Compatible*	MUL-IS-RPKS3010	MUL-IS-RPKS3020

One Piece Angled Abutment - 17°
Narrow Platform

	1mm 2.5mm	2mm 3.5mm
NobelActive™ Compatible*	MUL-NA-NPKS1710	MUL-NA-NPKS1720
Osstem® Hiossen® Compatible*	MUL-TS-NPKS1710	MUL-TS-NPKS1720
Astra Tech™TX Compatible*	MUL-OS-SPKS1710	MUL-OS-SPKS1720

One Piece Angled Abutment - 30°
Narrow Platform

	1mm 3.5mm	2mm 4.5mm
NobelActive™ Compatible*	MUL-NA-NPKS3010	MUL-NA-NPKS3020
Osstem® Hiossen® Compatible*	MUL-TS-NPKS3010	MUL-TS-NPKS3020
Astra Tech™TX Compatible*	MUL-OS-SPKS3010	MUL-OS-SPKS3020

* Registered trademarks are owned by their respective companies and there is no commercial relationship with Edison Medical. Its mention is made for proper identification purpose of the dental implants with which the Edison Medical abutments can be used.



One Piece Angled Abutment - 17°
Regular Platform

H G	1mm 2.5mm	2mm 3.5mm
NobelActive™ Compatible*	MUL-NA-RPKS1710H	MUL-NA-RPKS1720H
Osstem® Hiossen® Compatible*	MUL-TS-RPKS1710H	MUL-TS-RPKS1720H
Dentium® Compatible*	MUL-DE-RPKS1710H	MUL-DE-RPKS1720H
MegaGen® AnyOne Compatible*	MUL-AO-RPKS1710H	MUL-AO-RPKS1720H
MegaGen® AnyRidge Compatible*	MUL-AR-RPKS1710H	MUL-AR-RPKS1720H
Astra Tech™TX Compatible*	MUL-OS-WPKS1710H	MUL-OS-WPKS1720H
Dio Implant® Compatible*	MUL-UF-RPKS1710H	MUL-UF-RPKS1720H
NeoBiotech® Compatible*	MUL-IS-RPKS1710H	MUL-IS-RPKS1720H

One Piece Angled Abutment - 30°
Regular Platform

H G	1mm 3.5mm	2mm 4.5mm
NobelActive™ Compatible*	MUL-NA-RPKS3010H	MUL-NA-RPKS3020H
Osstem® Hiossen® Compatible*	MUL-TS-RPKS3010H	MUL-TS-RPKS3020H
Dentium® Compatible*	MUL-DE-RPKS3010H	MUL-DE-RPKS3020H
MegaGen® AnyOne Compatible*	MUL-AO-RPKS3010H	MUL-AO-RPKS3020H
MegaGen® AnyRidge Compatible*	MUL-AR-RPKS3010H	MUL-AR-RPKS3020H
Astra Tech™TX Compatible*	MUL-OS-WPKS3010H	MUL-OS-WPKS3020H
Dio Implant® Compatible*	MUL-UF-RPKS3010H	MUL-UF-RPKS3020H
NeoBiotech® Compatible*	MUL-IS-RPKS3010H	MUL-IS-RPKS3020H

One Piece Angled Abutment - 17°
Narrow Platform

H G	1mm 2.5mm	2mm 3.5mm
NobelActive™ Compatible*	MUL-NA-NPKS1710H	MUL-NA-NPKS1720H
Osstem® Hiossen® Compatible*	MUL-TS-NPKS1710H	MUL-TS-NPKS1720H
Astra Tech™TX Compatible*	MUL-OS-SPKS1710H	MUL-OS-SPKS1720H

One Piece Angled Abutment - 30°
Narrow Platform

H G	1mm 3.5mm	2mm 4.5mm
NobelActive™ Compatible*	MUL-NA-NPKS3010H	MUL-NA-NPKS3020H
Osstem® Hiossen® Compatible*	MUL-TS-NPKS3010H	MUL-TS-NPKS3020H
Astra Tech™TX Compatible*	MUL-OS-SPKS3010H	MUL-OS-SPKS3020H

* Registered trademarks are owned by their respective companies and there is no commercial relationship with Edison Medical. Its mention is made for proper identification purpose of the dental implants with which the Edison Medical abutments can be used.

Clicq™ - Multi Bar



Get a permanent bar
for your patient
within minutes

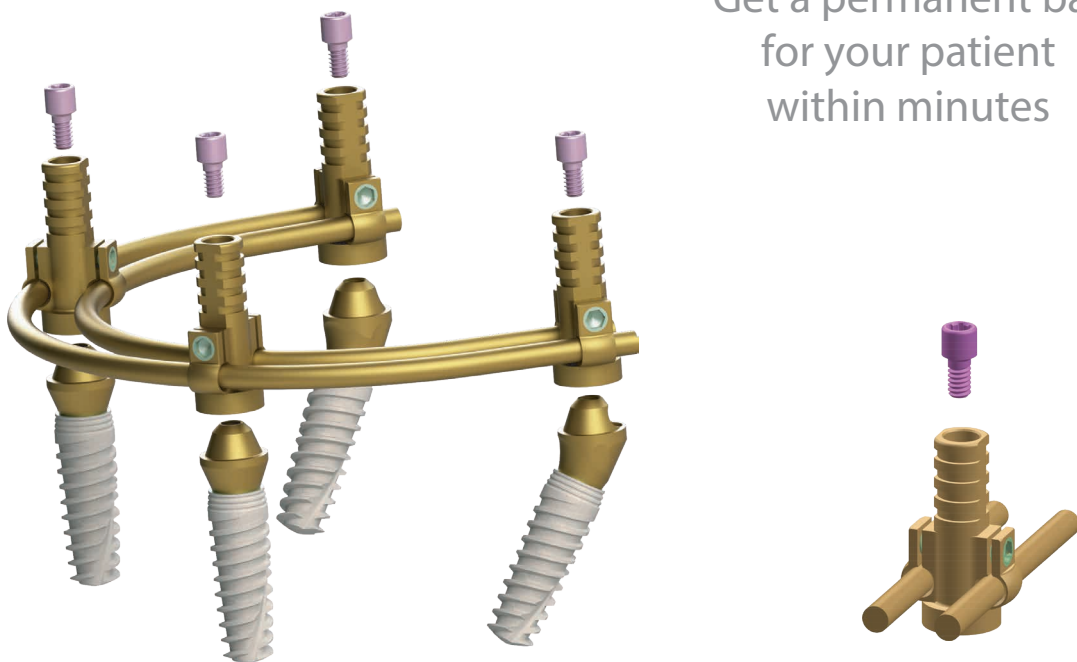



Design Patent Pending No. 62154
 Patent Pending No. US 62/679,389



Clicq™ - Multi Bar On4 Kit
 Regular Platform



(Screw Driver Included)

NobelActive™ Compatible*	MUL-NA-BK4	MUL-NA-BK4D
Osstem® Hiossen® Compatible*	MUL-TS-BK4	MUL-TS-BK4D
Dentium® Compatible*	MUL-DE-BK4	MUL-DE-BK4D
MegaGen® AnyOne Compatible*	MUL-AO-BK4	MUL-AO-BK4D
MegaGen® AnyRidge Compatible*	MUL-AR-BK4	MUL-AR-BK4D
Astra Tech™TX Compatible*	MUL-OS-BK4	MUL-OS-BK4D
Dio Implant® Compatible*	MUL-UF-BK4	MUL-UF-BK4D
NeoBiotech® Compatible*	MUL-IS-BK4	MUL-IS-BK4D

Clicq™ - Multi Bar On6 Kit
 Regular Platform



(Screw Driver Included)

NobelActive™ Compatible*	MUL-NA-BK6	MUL-NA-BK6D
Osstem® Hiossen® Compatible*	MUL-TS-BK6	MUL-TS-BK6D
Dentium® Compatible*	MUL-DE-BK6	MUL-DE-BK6D
MegaGen® AnyOne Compatible*	MUL-AO-BK6	MUL-AO-BK6D
MegaGen® AnyRidge Compatible*	MUL-AR-BK6	MUL-AR-BK6D
Astra Tech™TX Compatible*	MUL-OS-BK6	MUL-OS-BK6D
Dio Implant® Compatible*	MUL-UF-BK6	MUL-UF-BK6D
NeoBiotech® Compatible*	MUL-IS-BK6	MUL-IS-BK6D

Clicq™ - Multi Bar
 Components

 Bars *2

 Adjusting Micro Screw *2
 (spares)

 Prosthetic KS Ti-Screw
 On 4 - *6 (Incl. 2 spares)
 On 6 - *8 (Incl. 2 spares)











Pre-Fabricated Permanent
 Titanium Adjustable Sleeve *4/6
 W/ Adjusting Micro Screw *8/12

Hand Screw Driver



* Registered trademarks are owned by their respective companies and there is no commercial relationship with Edison Medical. Its mention is made for proper identification purpose of the dental implants with which the Edison Medical abutments can be used.



Straight Anatomic Abutment
Regular Platform

	H	L	1.5mm 9.5mm	3mm 11mm	4.5mm 12.5mm
NobelActive™ Compatible*					
ZAA-NA-RP15	ZAA-NA-RP30	ZAA-NA-RP45			
Osstem® Hiossen® Compatible*					
ZAA-TS-RP15	ZAA-TS-RP30	ZAA-TS-RP45			
Dentium® Compatible*					
ZAA-DE-RP15	ZAA-DE-RP30	ZAA-DE-RP45			
MegaGen® AnyOne Compatible*					
ZAA-AO-RP15	ZAA-AO-RP30	ZAA-AO-RP45			
MegaGen® AnyRidge Compatible*					
ZAA-AR-RP15	ZAA-AR-RP30	ZAA-AR-RP45			
Astra Tech™TX Compatible*					
ZAA-OS-WP15	ZAA-OS-WP30	ZAA-OS-WP45			
Dio Implant® Compatible*					
ZAA-UF-RP15	ZAA-UF-RP30	ZAA-UF-RP45			
NeoBiotech® Compatible*					
ZAA-IS-RP15	ZAA-IS-RP30	ZAA-IS-RP45			

Straight Anatomic Abutment
Narrow Platform

	H	L	1.5mm 9.5mm	3mm 11mm	4.5mm 12.5mm
NobelActive™ Compatible*					
ZAA-NA-NP15	ZAA-NA-NP30	ZAA-NA-NP45			
Osstem® Hiossen® Compatible*					
ZAA-TS-NP15	ZAA-TS-NP30	ZAA-TS-NP45			
Astra Tech™TX Compatible*					
ZAA-OS-SP15	ZAA-OS-SP30	ZAA-OS-SP45			

* Registered trademarks are owned by their respective companies and there is no commercial relationship with Edison Medical. Its mention is made for proper identification purpose of the dental implants with which the Edison Medical abutments can be used.



Angled Anatomic Abutment - 15°
Regular Platform

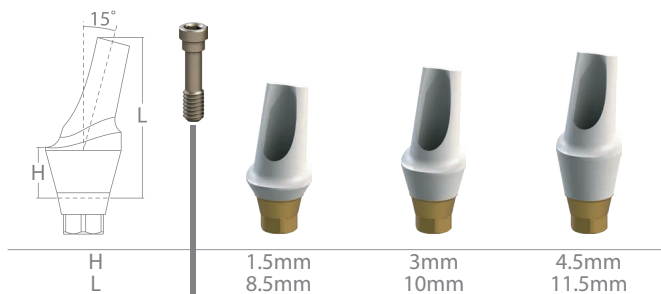

NobelActive™ Compatible*	ZAA-NA-RP1515	ZAA-NA-RP1530	ZAA-NA-RP1545
Osstem® Hiossen® Compatible*	ZAA-TS-RP1515	ZAA-TS-RP1530	ZAA-TS-RP1545
Dentium® Compatible*	ZAA-DE-RP1515	ZAA-DE-RP1530	ZAA-DE-RP1545
MegaGen® AnyOne Compatible*	ZAA-AO-RP1515	ZAA-AO-RP1530	ZAA-AO-RP1545
MegaGen® AnyRidge Compatible*	ZAA-AR-RP1515	ZAA-AR-RP1530	ZAA-AR-RP1545
Astra Tech™TX Compatible*	ZAA-OS-WP1515	ZAA-OS-WP1530	ZAA-OS-WP1545
Dio Implant® Compatible*	ZAA-UF-RP1515	ZAA-UF-RP1530	ZAA-UF-RP1545
NeoBiotech® Compatible*	ZAA-IS-RP1515	ZAA-IS-RP1530	ZAA-IS-RP1545

Angled Anatomic Abutment - 25°
Regular Platform

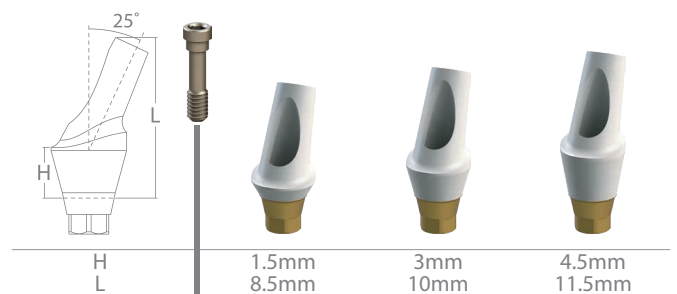

NobelActive™ Compatible*	ZAA-NA-RP2515	ZAA-NA-RP2530	ZAA-NA-RP2545
Osstem® Hiossen® Compatible*	ZAA-TS-RP2515	ZAA-TS-RP2530	ZAA-TS-RP2545
Dentium® Compatible*	ZAA-DE-RP2515	ZAA-DE-RP2530	ZAA-DE-RP2545
MegaGen® AnyOne Compatible*	ZAA-AO-RP2515	ZAA-AO-RP2530	ZAA-AO-RP2545
MegaGen® AnyRidge Compatible*	ZAA-AR-RP2515	ZAA-AR-RP2530	ZAA-AR-RP2545
Astra Tech™TX Compatible*	ZAA-OS-WP2515	ZAA-OS-WP2530	ZAA-OS-WP2545
Dio Implant® Compatible*	ZAA-UF-RP2515	ZAA-UF-RP2530	ZAA-UF-RP2545
NeoBiotech® Compatible*	ZAA-IS-RP2515	ZAA-IS-RP2530	ZAA-IS-RP2545

Angled Anatomic Abutment - 15°
Narrow Platform

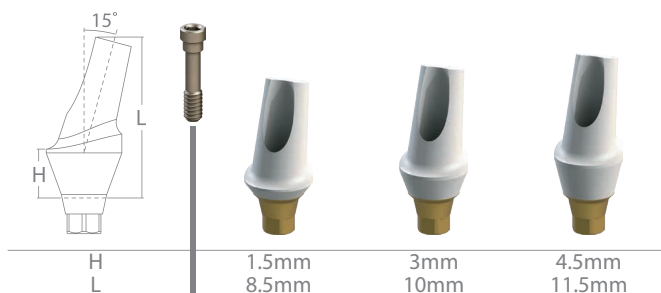

NobelActive™ Compatible*	ZAA-NA-NP1515	ZAA-NA-NP1530	ZAA-NA-NP1545
Osstem® Hiossen® Compatible*	ZAA-TS-NP1515	ZAA-TS-NP1530	ZAA-TS-NP1545
Astra Tech™TX Compatible*	ZAA-OS-SP1515	ZAA-OS-SP1530	ZAA-OS-SP1545

Angled Anatomic Abutment - 25°
Narrow Platform

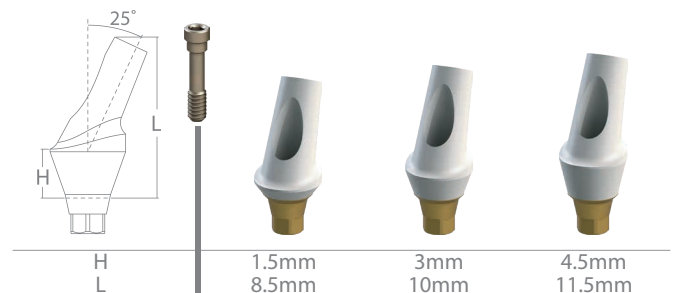

NobelActive™ Compatible*	ZAA-NA-NP2515	ZAA-NA-NP2530	ZAA-NA-NP2545
Osstem® Hiossen® Compatible*	ZAA-TS-NP2515	ZAA-TS-NP2530	ZAA-TS-NP2545
Astra Tech™TX Compatible*	ZAA-OS-SP2515	ZAA-OS-SP2530	ZAA-OS-SP2545

* Registered trademarks are owned by their respective companies and there is no commercial relationship with Edison Medical. Its mention is made for proper identification purpose of the dental implants with which the Edison Medical abutments can be used.



Straight Anatomic Abutment
Regular Platform

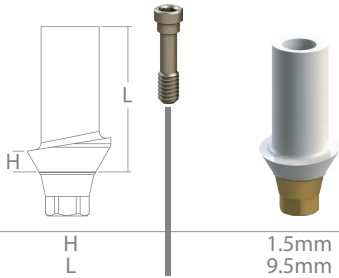

NobelActive™ Compatible*	ZAAU-NA-RP15
Osstem® Hiossen® Compatible*	ZAAU-TS-RP15
Dentium® Compatible*	ZAAU-DE-RP15
MegaGen® AnyOne Compatible*	ZAAU-AO-RP15
MegaGen® AnyRidge Compatible*	ZAAU-AR-RP15
Astra Tech™TX Compatible*	ZAAU-OS-WP15
Dio Implant® Compatible*	ZAAU-UF-RP15
NeoBiotech® Compatible*	ZAAU-IS-RP15

Angled Anatomic Abutment - 15°
Regular Platform

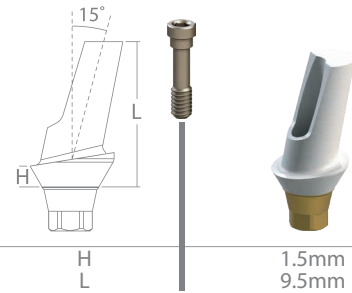

NobelActive™ Compatible*	ZAAU-NA-RP1515
Osstem® Hiossen® Compatible*	ZAAU-TS-RP1515
Dentium® Compatible*	ZAAU-DE-RP1515
MegaGen® AnyOne Compatible*	ZAAU-AO-RP1515
MegaGen® AnyRidge Compatible*	ZAAU-AR-RP1515
Astra Tech™TX Compatible*	ZAAU-OS-WP1515
Dio Implant® Compatible*	ZAAU-UF-RP1515
NeoBiotech® Compatible*	ZAAU-IS-RP1515

Straight Anatomic Abutment
Narrow Platform

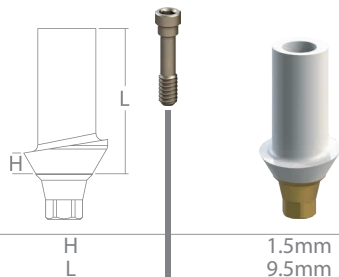

NobelActive™ Compatible*	ZAAU-NA-NP15
Osstem® Hiossen® Compatible*	ZAAU-TS-NP15
Astra Tech™TX Compatible*	ZAAU-OS-SP15

Angled Anatomic Abutment - 15°
Narrow Platform

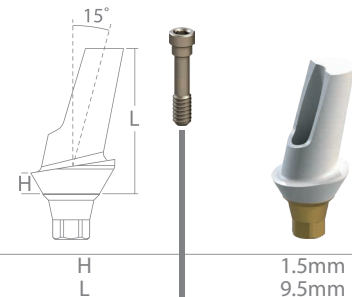

NobelActive™ Compatible*	ZAAU-NA-NP1515
Osstem® Hiossen® Compatible*	ZAAU-TS-NP1515
Astra Tech™TX Compatible*	ZAAU-OS-SP1515

* Registered trademarks are owned by their respective companies and there is no commercial relationship with Edison Medical. Its mention is made for proper identification purpose of the dental implants with which the Edison Medical abutments can be used.



Titanium Abutment
Regular Platform

	10.5mm	10.5mm (Castable Plastic Sleeve included)	12mm	12mm
NobelActive™ Compatible *	ABZ-NA-RPTI	ABZ-NA-RPTIR		
Osstem® Hiossen® Compatible *	ABZ-TS-RPTI	ABZ-TS-RPTIR		
Dentium® Compatible *	ABZ-DE-RPTI	ABZ-DE-RPTIR		
MegaGen® AnyOne Compatible *	ABZ-AO-RPTI	ABZ-AO-RPTIR		
MegaGen® AnyRidge Compatible *			ABZ-AR-RPTI	ABZ-AR-RPTIR
Astra Tech™TX Compatible *	ABZ-OS-WPTI	ABZ-OS-WPTIR		
Dio Implant® Compatible *	ABZ-UF-RPTI	ABZ-UF-RPTIR		
NeoBiotech® Compatible *	ABZ-IS-RPTI	ABZ-IS-RPTIR		

(Castable Plastic Sleeve included)

Titanium Abutment
Narrow Platform

	10.5mm	10.5mm (Castable Plastic Sleeve included)
NobelActive™ Compatible *	ABZ-NA-NPTI	ABZ-NA-NPTIR
Osstem® Hiossen® Compatible *	ABZ-TS-NPTI	ABZ-TS-NPTIR
Astra Tech™TX Compatible *	ABZ-OS-SPTI	ABZ-OS-SPTIR

(Castable Plastic Sleeve included)

* Registered trademarks are owned by their respective companies and there is no commercial relationship with Edison Medical. Its mention is made for proper identification purpose of the dental implants with which the Edison Medical abutments can be used.



Chrome Cobalt Abutment
Regular Platform

	10.5mm	10.5mm (Castable Plastic Sleeve included)	12mm	12mm
NobelActive™ Compatible *	ABZ-NA-RPCC	ABZ-NA-RPCCR		
Osstem® Hiossen® Compatible *	ABZ-TS-RPCC	ABZ-TS-RPCCR		
Dentium® Compatible *	ABZ-DE-RPCC	ABZ-DE-RPCCR		
MegaGen® AnyOne Compatible *	ABZ-AO-RPCC	ABZ-AO-RPCCR		
MegaGen® AnyRidge Compatible *			ABZ-AR-RPCC	ABZ-AR-RPCCR
Astra Tech™TX Compatible *	ABZ-OS-WPCC	ABZ-OS-WPCCR		
Dio Implant® Compatible *	ABZ-UF-RPCC	ABZ-UF-RPCCR		
NeoBiotech® Compatible *	ABZ-IS-RPCC	ABZ-IS-RPCCR		

(Castable Plastic Sleeve included)

Chrome Cobalt Abutment
Narrow Platform

	10.5mm	10.5mm (Castable Plastic Sleeve included)
NobelActive™ Compatible *	ABZ-NA-NPCC	ABZ-NA-NPCCR
Osstem® Hiossen® Compatible *	ABZ-TS-NPCC	ABZ-TS-NPCCR
Astra Tech™TX Compatible *	ABZ-OS-SPCC	ABZ-OS-SPCCR

(Castable Plastic Sleeve included)

* Registered trademarks are owned by their respective companies and there is no commercial relationship with Edison Medical. Its mention is made for proper identification purpose of the dental implants with which the Edison Medical abutments can be used.



Plastic Abutment for Casting
Regular Platform

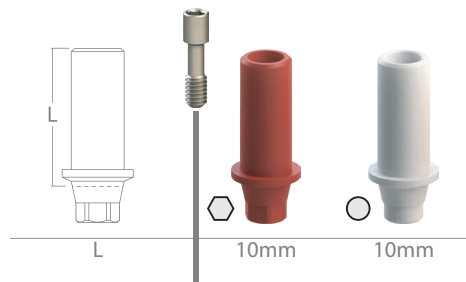

NobelActive™ Compatible*	PAC-NA-RP	PAC-NA-RPR
Osstem® Hiossen® Compatible*	PAC-TS-RP	PAC-TS-RPR
Dentium® Compatible*	PAC-DE-RP	PAC-DE-RPR
MegaGen® AnyOne Compatible*	PAC-AO-RP	PAC-AO-RPR
MegaGen® AnyRidge Compatible*	PAC-AR-RP	PAC-AR-RPR
Astra Tech™TX Compatible*	PAC-OS-WP	PAC-OS-WPR
Dio Implant® Compatible*	PAC-UF-RP	PAC-UF-RPR
NeoBiotech® Compatible*	PAC-IS-RP	PAC-IS-RPR

Plastic Abutment for Casting
Narrow Platform

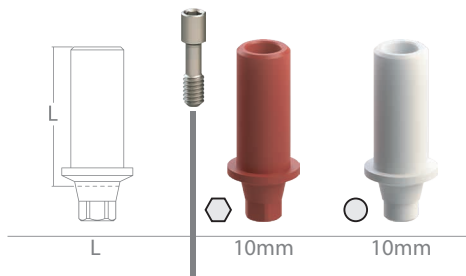

NobelActive™ Compatible*	PAC-NA-NP	PAC-NA-NPR
Osstem® Hiossen® Compatible*	PAC-TS-NP	PAC-TS-NPR
Astra Tech™TX Compatible*	PAC-OS-SP	PAC-OS-SPR

* Registered trademarks are owned by their respective companies and there is no commercial relationship with Edison Medical. Its mention is made for proper identification purpose of the dental implants with which the Edison Medical abutments can be used.



PEEK Scan Abutment
Regular Platform

NobelActive™ Compatible *	SB-NA-RP
Osstem® Hiossen® Compatible *	SB-TS-RP
Dentium® Compatible *	SB-DE-RP
MegaGen® AnyOne Compatible *	SB-AO-RP
MegaGen® AnyRidge Compatible *	SB-AR-RP
Astra Tech™TX Compatible *	SB-OS-WP
Dio Implant® Compatible *	SB-UF-RP
NeoBiotech® Compatible *	SB-IS-RP

PEEK Scan Abutment
Narrow Platform

NobelActive™ Compatible *	SB-NA-NP
Osstem® Hiossen® Compatible *	SB-TS-NP
Astra Tech™TX Compatible *	SB-OS-SP

Scan Body (Non PEEK)
for Regular & Narrow Platform

Sirona CEREC®
Compatible *

SB-TBC



* Registered trademarks are owned by their respective companies and there is no commercial relationship with Edison Medical. Its mention is made for proper identification purpose of the dental implants with which the Edison Medical abutments can be used.



Titanium Base
Regular Platform

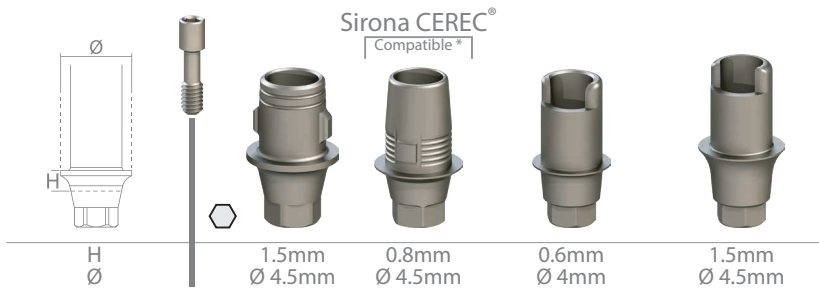

NobelActive™ Compatible *	TB-NA-RP	TBC-NA-RP		
Osstem® Hiossen® Compatible *		TBC-TS-RP		
Dentium® Compatible *		TBC-DE-RP		
MegaGen® AnyOne Compatible *		TBC-AO-RP	TB-AO-RP4045	TB-AO-RP4545
MegaGen® AnyRidge Compatible *		TBC-AR-RP	TB-AR-RP4045	TB-AR-RP4545
Astra Tech™TX Compatible *		TBC-OS-WP		
Dio Implant® Compatible *		TBC-UF-RP		
NeoBiotech® Compatible *		TBC-IS-RP		

Angled Titanium Base 10°
Regular Platform

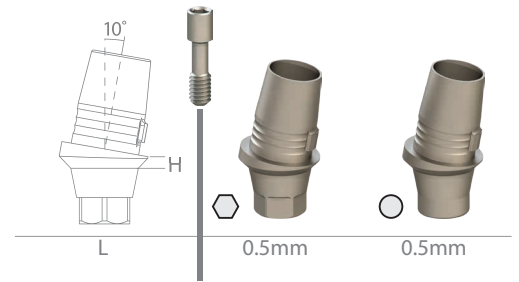

NobelActive™ Compatible *	TBC-NA-RP1000	TBC-NA-RP1000R		
Osstem® Hiossen® Compatible *	TBC-TS-RP1000	TBC-TS-RP1000R		
Dentium® Compatible *	TBC-DE-RP1000	TBC-DE-RP1000R		
MegaGen® AnyOne Compatible *	TBC-AO-RP1000	TBC-AO-RP1000R		
MegaGen® AnyRidge Compatible *	TBC-AR-RP1000	TBC-AR-RP1000R		
Astra Tech™TX Compatible *	TBC-OS-WP1000	TBC-OS-WP1000R		
Dio Implant® Compatible *	TBC-UF-RP1000	TBC-UF-RP1000R		
NeoBiotech® Compatible *	TBC-IS-RP1000	TBC-IS-RP1000R		

Titanium Base
Narrow Platform

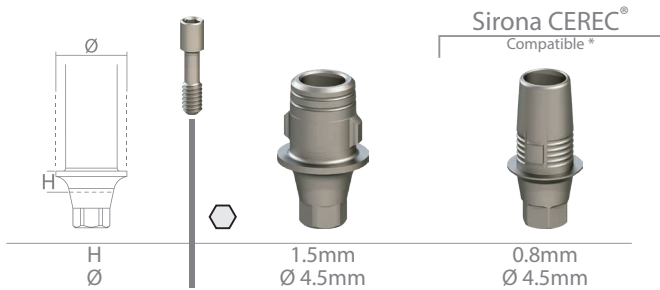

NobelActive™ Compatible *	TB-NA-NP	TBC-NA-NP		
Osstem® Hiossen® Compatible *		TBC-TS-NP		
Astra Tech™TX Compatible *		TBC-OS-SP		

Angled Titanium Base 10°
Narrow Platform

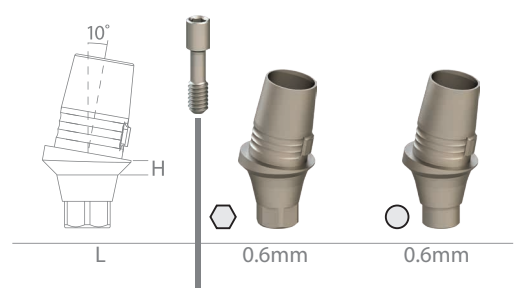

NobelActive™ Compatible *	TBC-NA-NP1000	TBC-NA-NP1000R		
Osstem® Hiossen® Compatible *	TBC-TS-NP1000	TBC-NA-NP1000R		
Astra Tech™TX Compatible *	TBC-OS-SP1000	TBC-NA-SP1000R		

* Registered trademarks are owned by their respective companies and there is no commercial relationship with Edison Medical. Its mention is made for proper identification purpose of the dental implants with which the Edison Medical abutments can be used.



Pre-Milled Titanium Blank
Regular Platform

	Arum Compatible *	Medentika Compatible *	NT-Trading Compatible *
NobelActive™ Compatible *	PMAM-NA-RP	PMMD-NA-RP	PMNT-NA-RP
Osstem® Hiossen® Compatible *	PMAM-TS-RP	PMMD-TS-RP	PMNT-TS-RP
Dentium® Compatible *	PMAM-DE-RP	PMMD-DE-RP	PMNT-DE-RP
MegaGen® AnyOne Compatible *	PMAM-AO-RP	PMMD-AO-RP	PMNT-AO-RP
MegaGen® AnyRidge Compatible *	PMAM-AR-RP	PMMD-AR-RP	PMNT-AR-RP
Astra Tech™TX Compatible *	PMAM-OS-WP	PMMD-OS-WP	PMNT-OS-WP
Dio Implant® Compatible *	PMAM-UF-RP	PMMD-UF-RP	PMNT-UF-RP
NeoBiotech® Compatible *	PMAM-IS-RP	PMMD-IS-RP	PMNT-IS-RP

Pre-Milled Titanium Blank
Narrow Platform

	Arum Compatible *	Medentika Compatible *	NT-Trading Compatible *
NobelActive™ Compatible *	PMAM-NA-NP	PMMD-NA-NP	PMNT-NA-NP
Osstem® Hiossen® Compatible *	PMAM-TS-NP	PMMD-TS-NP	PMNT-TS-NP
Astra Tech™TX Compatible *	PMAM-OS-SP	PMMD-OS-SP	PMNT-OS-SP

* Registered trademarks are owned by their respective companies and there is no commercial relationship with Edison Medical. Its mention is made for proper identification purpose of the dental implants with which the Edison Medical abutments can be used.



Pre-Milled Titanium Blank - Rotational
Regular Platform

	Arum Compatible *	Medentika Compatible *	NT-Trading Compatible *
NobelActive™ Compatible *	PMAM-NA-RPR	PMMD-NA-RPR	PMNT-NA-RPR
Osstem® Hiossen® Compatible *	PMAM-TS-RPR	PMMD-TS-RPR	PMNT-TS-RPR
Dentium® Compatible *	PMAM-DE-RPR	PMMD-DE-RPR	PMNT-DE-RPR
MegaGen® AnyOne Compatible *	PMAM-AO-RPR	PMMD-AO-RPR	PMNT-AO-RPR
MegaGen® AnyRidge Compatible *	PMAM-AR-RPR	PMMD-AR-RPR	PMNT-AR-RPR
Astra Tech™TX Compatible *	PMAM-OS-WPR	PMMD-OS-WPR	PMNT-OS-WPR
Dio Implant® Compatible *	PMAM-UF-RPR	PMMD-UF-RPR	PMNT-UF-RPR
NeoBiotech® Compatible *	PMAM-IS-RPR	PMMD-IS-RPR	PMNT-IS-RPR

Pre-Milled Titanium Blank - Rotational
Narrow Platform

	Arum Compatible *	Medentika Compatible *	NT-Trading Compatible *
NobelActive™ Compatible *	PMAM-NA-NPR	PMMD-NA-NPR	PMNT-NA-NPR
Osstem® Hiossen® Compatible *	PMAM-TS-NPR	PMMD-TS-NPR	PMNT-TS-NPR
Astra Tech™TX Compatible *	PMAM-OS-SPR	PMMD-OS-SPR	PMNT-OS-SPR

* Registered trademarks are owned by their respective companies and there is no commercial relationship with Edison Medical. Its mention is made for proper identification purpose of the dental implants with which the Edison Medical abutments can be used.



Abutment Gauge Kit
Regular Platform

NobelActive™ Compatible *	AG-NA-RPK
Osstem® Hiossen® Compatible *	AG-TS-RPK
Dentium® Compatible *	AG-DE-RPK
MegaGen® AnyOne Compatible *	AG-AO-RPK
MegaGen® AnyRidge Compatible *	AG-AR-RPK
Astra Tech™TX Compatible *	AG-OS-WPK
Dio Implant® Compatible *	AG-UF-RPK
NeoBiotech® Compatible *	AG-IS-RPK

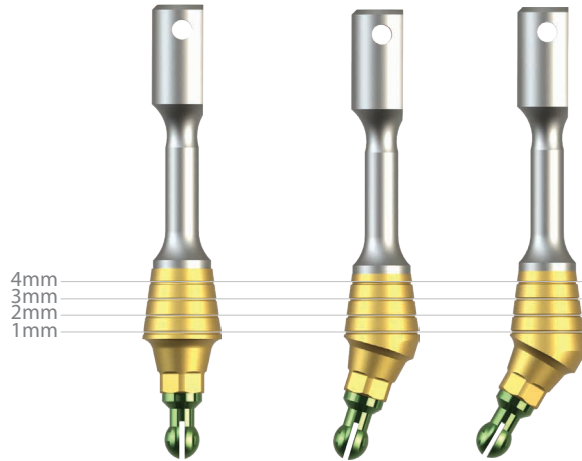

Abutment Gauge Kit
Narrow Platform

NobelActive™ Compatible *	AG-NA-NPK
Osstem® Hiossen® Compatible *	AG-TS-NPK
Astra Tech™TX Compatible *	AG-OS-SPK



* Registered trademarks are owned by their respective companies and there is no commercial relationship with Edison Medical. Its mention is made for proper identification purpose of the dental implants with which the Edison Medical abutments can be used.



Abutment Gauge Straight
Regular Platform

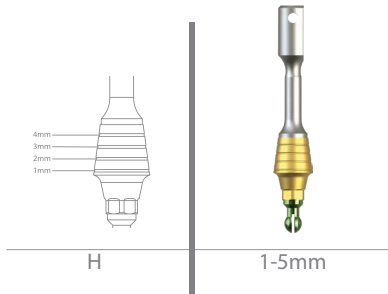

NobelActive™ Compatible *	AG-NA-RP00
Osstem® Hiossen® Compatible *	AG-TS-RP00
Dentium® Compatible *	AG-DE-RP00
MegaGen® AnyOne Compatible *	AG-AO-RP00
MegaGen® AnyRidge Compatible *	AG-AR-RP00
Astra Tech™TX Compatible *	AG-OS-WP00
Dio Implant® Compatible *	AG-UF-RP00
NeoBiotech® Compatible *	AG-IS-RP00

Abutment Gauge - 17°
Regular Platform

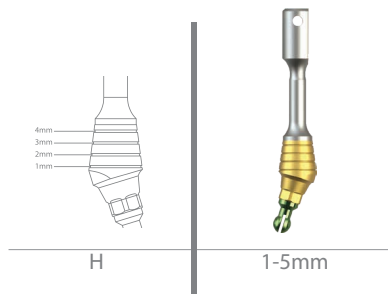

NobelActive™ Compatible *	AG-NA-RP1700
Osstem® Hiossen® Compatible *	AG-TS-RP1700
Dentium® Compatible *	AG-DE-RP1700
MegaGen® AnyOne Compatible *	AG-AO-RP1700
MegaGen® AnyRidge Compatible *	AG-AR-RP1700
Astra Tech™TX Compatible *	AG-OS-WP1700
Dio Implant® Compatible *	AG-UF-RP1700
NeoBiotech® Compatible *	AG-IS-RP1700

Abutment Gauge - 30°
Regular Platform

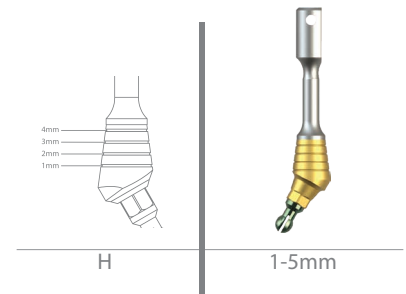

NobelActive™ Compatible *	AG-NA-RP3000
Osstem® Hiossen® Compatible *	AG-TS-RP3000
Dentium® Compatible *	AG-DE-RP3000
MegaGen® AnyOne Compatible *	AG-AO-RP3000
MegaGen® AnyRidge Compatible *	AG-AR-RP3000
Astra Tech™TX Compatible *	AG-OS-WP3000
Dio Implant® Compatible *	AG-UF-RP3000
NeoBiotech® Compatible *	AG-IS-RP3000

Abutment Gauge Straight
Narrow Platform

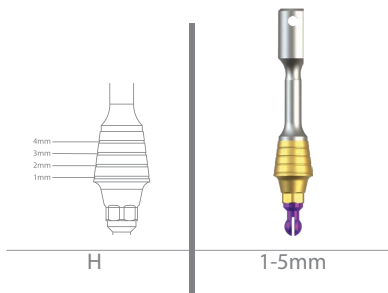

NobelActive™ Compatible *	AG-NA-NP00
Osstem® Hiossen® Compatible *	AG-TS-NP00
Astra Tech™TX Compatible *	AG-OS-SP00

Abutment Gauge - 17°
Narrow Platform

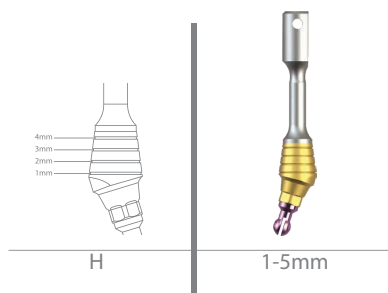

NobelActive™ Compatible *	AG-NA-NP1700
Osstem® Hiossen® Compatible *	AG-TS-NP1700
Astra Tech™TX Compatible *	AG-OS-SP1700

Abutment Gauge - 30°
Narrow Platform

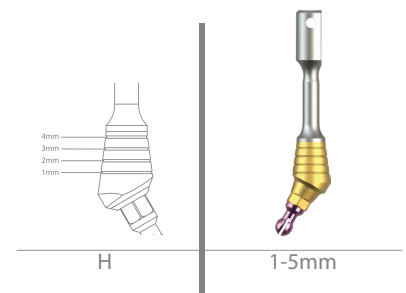

NobelActive™ Compatible *	AG-NA-NP3000
Osstem® Hiossen® Compatible *	AG-TS-NP3000
Astra Tech™TX Compatible *	AG-OS-SP3000

* Registered trademarks are owned by their respective companies and there is no commercial relationship with Edison Medical. Its mention is made for proper identification purpose of the dental implants with which the Edison Medical abutments can be used.



 ***Internal
Hex*** 



Lamina®



INTERNAL HEX Connection

Regular Platform

Ø L	Implant Diameter		
	3.5mm	4.2mm	5.0mm
8mm	LM-SV-RP3508	LM-SV-RP4208	LM-SV-RP5008
10mm	LM-SV-RP3510	LM-SV-RP4210	LM-SV-RP5010
11.5mm	LM-SV-RP3511	LM-SV-RP4211	LM-SV-RP5011
13mm	LM-SV-RP3513	LM-SV-RP4213	LM-SV-RP5013
15mm	LM-SV-RP3515	LM-SV-RP4215	

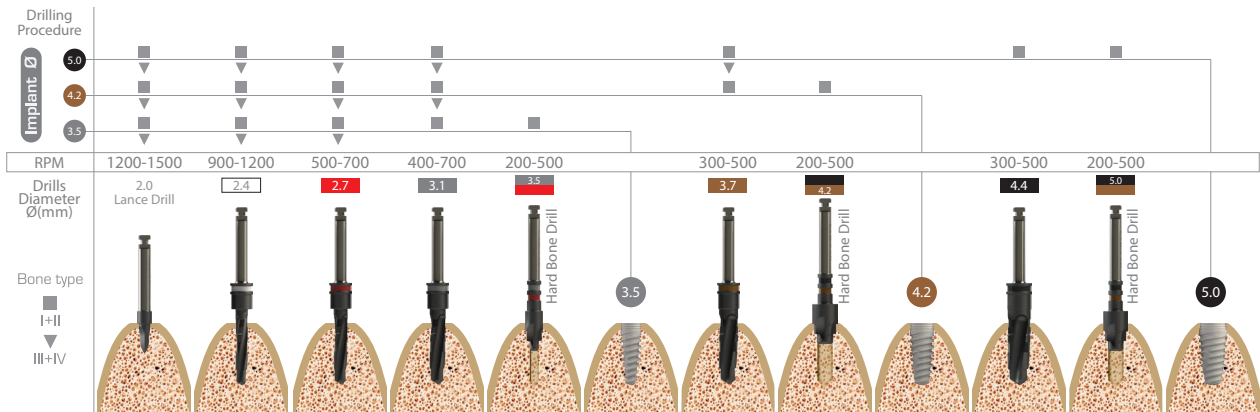

* Registered trademarks are owned by their respective companies and there is no commercial relationship with Edison Medical. Its mention is made for proper identification purpose of the dental implants with which the Edison Medical abutments can be used.



Titanium Implant Analog
Regular Platform

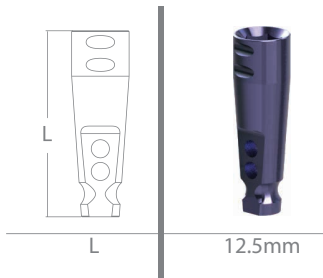

Internal Hex
Compatible* | IA-SV-RP

Angled Closed Tray 15°
Regular Platform

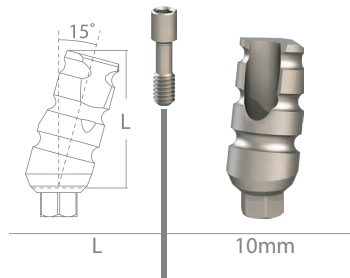

Internal Hex
Compatible* | ACTT-SV-RP1500

Angled Closed Tray 25°
Regular Platform

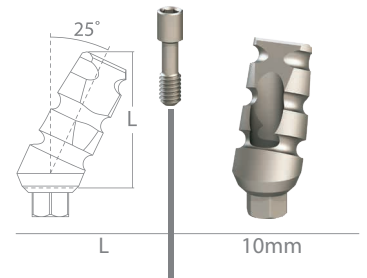

Internal Hex
Compatible* | ACTT-SV-RP2500

Patent Pending US 62/416.368 *Clicq Trans™*
Angled Closed Tray Impression Coping

Closed Tray Impression Coping - Narrow - Ø 4mm
Regular Platform

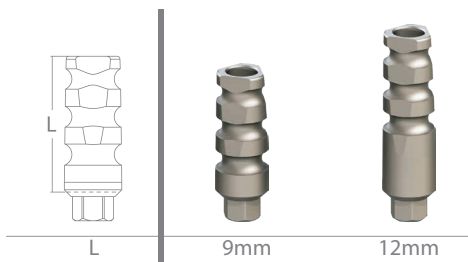

Internal Hex
Compatible* | CT-SV-RPSN | CT-SV-RPLN

Closed Tray Impression Coping - Ø 4.5mm
Regular Platform

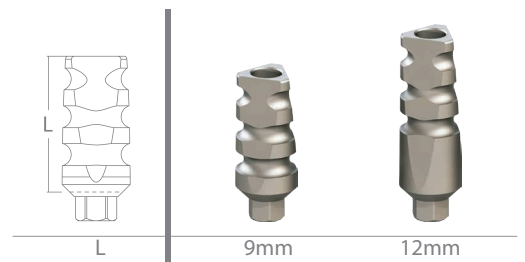

Internal Hex
Compatible* | CT-SV-RPS | CT-SV-RPL



Open Tray Impression Coping
Regular Platform

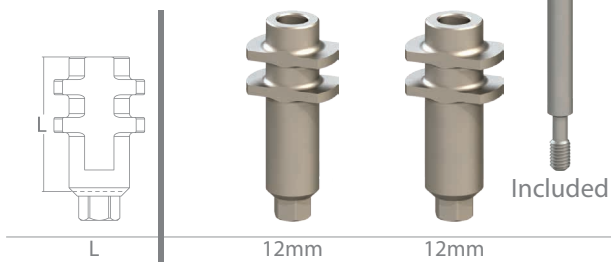

Internal Hex
Compatible* | OT-SV-RPN | OT-SV-RP



* Registered trademarks are owned by their respective companies and there is no commercial relationship with Edison Medical. Its mention is made for proper identification purpose of the dental implants with which the Edison Medical abutments can be used.



Titanium Healing Abutment 3mm
Regular Platform

H Ø	3mm 3.8mm	3mm 4.5mm	3mm 5.5mm	3mm 6.3mm
Internal Hex Compatible*	HA-SV-RP30N	HA-SV-RP30	HA-SV-RP30W	HA-SV-RP30EW

Titanium Healing Abutment 5mm
Regular Platform

H Ø	5mm 3.8mm	5mm 4.5mm	5mm 5.5mm	5mm 6.3mm
Internal Hex Compatible*	HA-SV-RP50N	HA-SV-RP50	HA-SV-RP50W	HA-SV-RP50EW

Concave Titanium Healing Abutment 3mm
Regular Platform

H Ø	3mm 4.5mm
Internal Hex Compatible*	HAC-SV-RP30

Concave Titanium Healing Abutment 5mm
Regular Platform

H Ø	5mm 4.5mm
Internal Hex Compatible*	HAC-SV-RP50

* Registered trademarks are owned by their respective companies and there is no commercial relationship with Edison Medical. Its mention is made for proper identification purpose of the dental implants with which the Edison Medical abutments can be used.



Temporary Titanium Abutment
Regular Platform

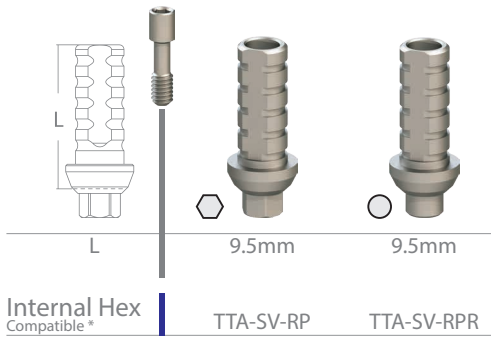

PEEK - Straight Abutment
Regular Platform

Medical Peek - Classix



PEEK - Anatomic Angled Abutment 15°
Regular Platform

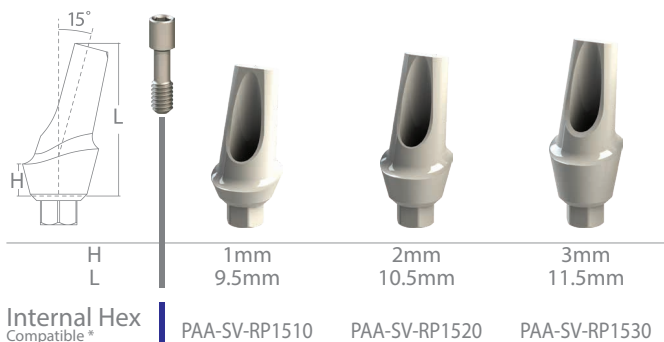

PEEK - Anatomic Angled Abutment 25°
Regular Platform

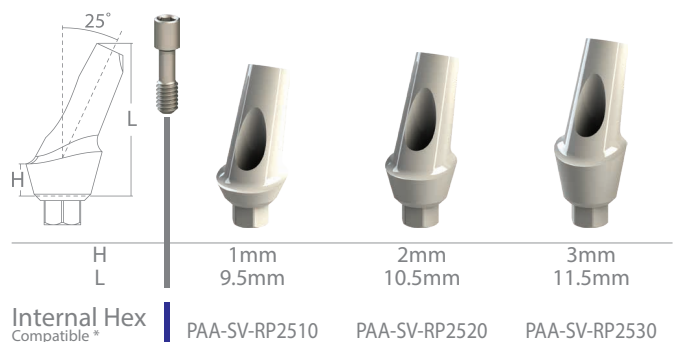

* Registered trademarks are owned by their respective companies and there is no commercial relationship with Edison Medical. Its mention is made for proper identification purpose of the dental implants with which the Edison Medical abutments can be used.



Straight Abutment - Ø 4.5mm
Regular Platform

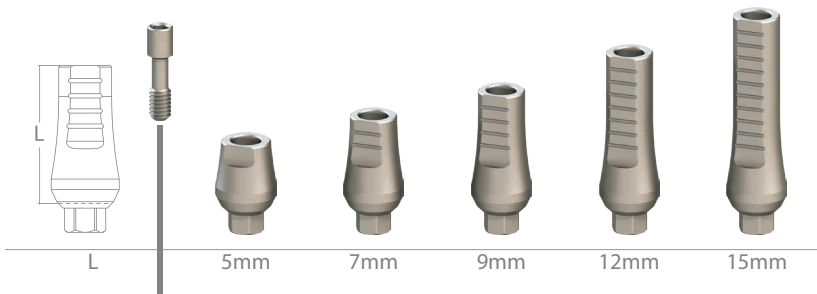

Internal Hex Compatible* | SA-SV-RP5 SA-SV-RP7 SA-SV-RP9 SA-SV-RP12 SA-SV-RP15

Straight Abutment - Wide - Ø 5.5mm
Regular Platform

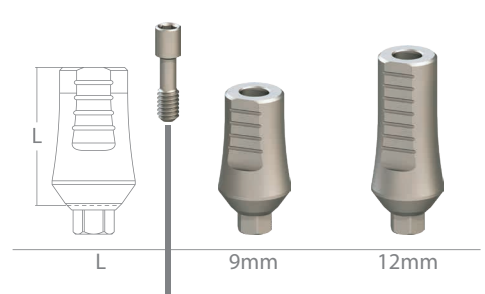

Internal Hex Compatible* | SA-SV-RP9W SA-SV-RP12W

Straight Slim Abutment
Regular Platform

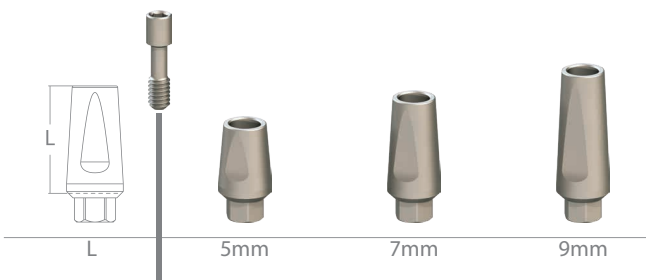

Internal Hex Compatible* | SSA-SV-RP5 SSA-SV-RP7 SSA-SV-RP9

Angled Abutment 15°
Regular Platform

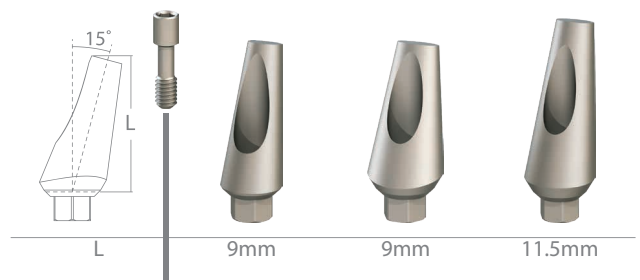

Internal Hex Compatible* | TA-SV-RP1500N TA-SV-RP1500 TA-SV-RP1500L

Angled Abutment 25°
Regular Platform

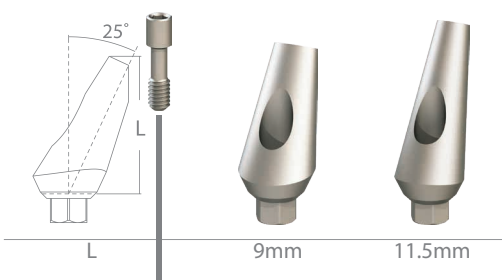

Internal Hex Compatible* | TA-SV-RP2500 TA-SV-RP2500L

Angled Abutment 35°
Regular Platform

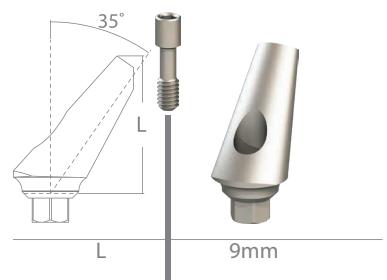

Internal Hex Compatible* | TA-SV-RP3500

* Registered trademarks are owned by their respective companies and there is no commercial relationship with Edison Medical. Its mention is made for proper identification purpose of the dental implants with which the Edison Medical abutments can be used.



Straight Abutment W/Shoulder
Regular Platform

H	1mm	2mm	3mm	4mm
Internal Hex Compatible *	TA-SV-RP10	TA-SV-RP20	TA-SV-RP30	TA-SV-RP40

Concave Straight Abutment W/Shoulder
Regular Platform

H	1mm	2mm	3mm	4mm
Internal Hex Compatible *	TAC-SV-RP10	TAC-SV-RP20	TAC-SV-RP30	TAC-SV-RP40

Anatomic Straight Abutment
Regular Platform

H L	1mm 9.4mm	2mm 10.4mm	3mm 11.4mm	4mm 12.4mm
Internal Hex Compatible *	TAA-SV-RP10	TAA-SV-RP20	TAA-SV-RP30	TAA-SV-RP40

Concave Anatomic Straight Abutment
Regular Platform

H L	1mm 9.4mm	2mm 10.4mm	3mm 11.4mm	4mm 12.4mm
Internal Hex Compatible *	TAAC-SV-RP10	TAAC-SV-RP20	TAAC-SV-RP30	TAAC-SV-RP40

* Registered trademarks are owned by their respective companies and there is no commercial relationship with Edison Medical. Its mention is made for proper identification purpose of the dental implants with which the Edison Medical abutments can be used.



⬡ Anatomic Angled Abutment - 15°
Regular Platform

	1mm 9.4mm	2mm 10.4mm	3mm 11.4mm	4mm 12.4mm
Internal Hex Compatible*	TAA-SV-RP1510	TAA-SV-RP1520	TAA-SV-RP1530	TAA-SV-RP1540

⬡ Concave Anatomic Angled Abutment - 15°
Regular Platform

	1mm 9.4mm	2mm 10.4mm	3mm 11.4mm	4mm 12.4mm
Internal Hex Compatible*	TAAC-SV-RP1510	TAAC-SV-RP1520	TAAC-SV-RP1530	TAAC-SV-RP1540

⬡ Anatomic Angled Abutment - 25°
Regular Platform

	1mm 9.4mm	2mm 10.4mm	3mm 11.4mm	4mm 12.4mm
Internal Hex Compatible*	TAA-SV-RP2510	TAA-SV-RP2520	TAA-SV-RP2530	TAA-SV-RP2540

⬡ Concave Anatomic Angled Abutment - 25°
Regular Platform

	1mm 9.4mm	2mm 10.4mm	3mm 11.4mm	4mm 12.4mm
Internal Hex Compatible*	TAAC-SV-RP2510	TAAC-SV-RP2520	TAAC-SV-RP2530	TAAC-SV-RP2540

* Registered trademarks are owned by their respective companies and there is no commercial relationship with Edison Medical. Its mention is made for proper identification purpose of the dental implants with which the Edison Medical abutments can be used.

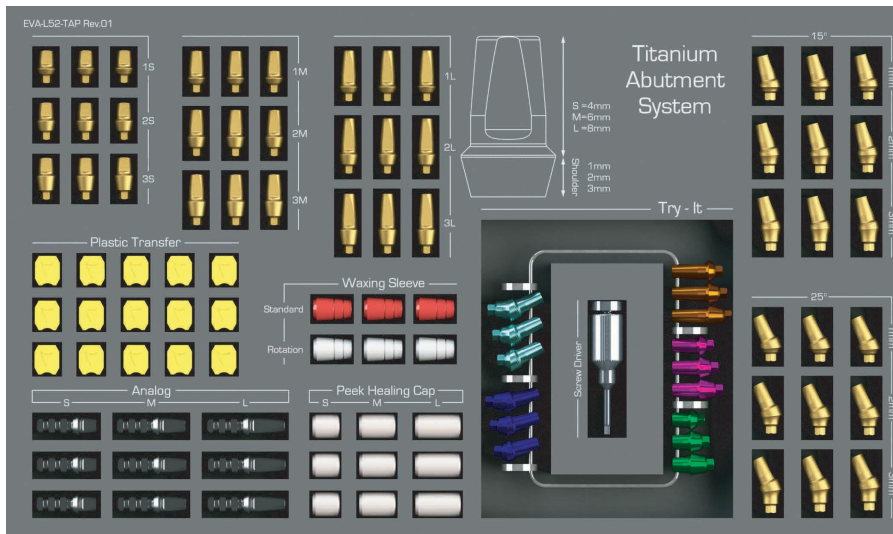

Professional Kit REF

Internal Hex
Compatible*

TAP-SV-RPPK

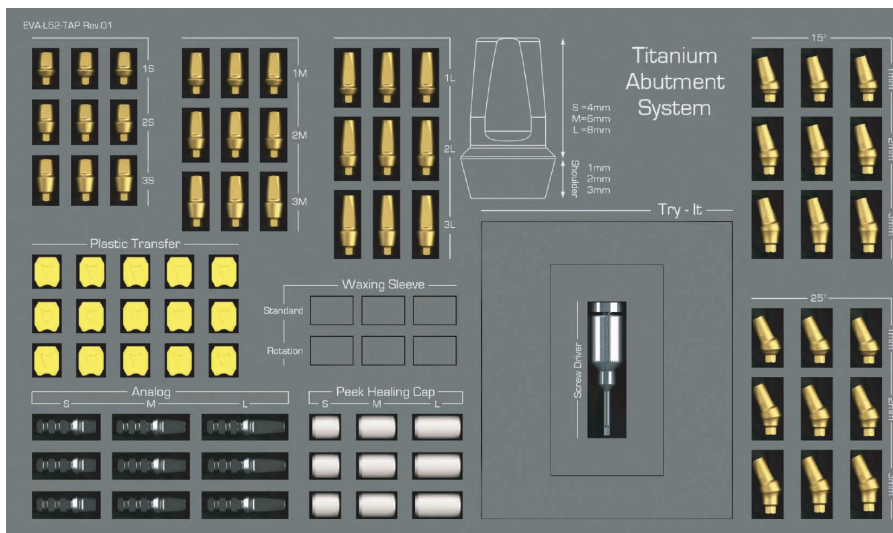

Starter Kit REF

Internal Hex
Compatible*

TAP-SV-RPSK

Clicq™ Pression
Components

Abutment Analog

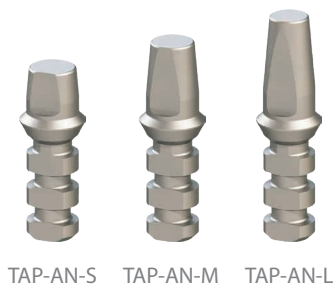

Medical Peek - Classix

Healing Cap PEEK

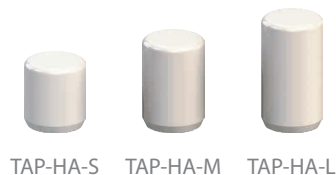

Waxing Sleeve



Plastic Transfer



* Registered trademarks are owned by their respective companies and there is no commercial relationship with Edison Medical. Its mention is made for proper identification purpose of the dental implants with which the Edison Medical abutments can be used.



Contents:

- Straight / Angled Abutment
- Titanium Screw
- Plastic Transfer

Straight Transfer Abutment - Short
Regular Platform

Internal Hex Compatible* | TAP-SV-RP10S | TAP-SV-RP20S | TAP-SV-RP30S

Straight Transfer Abutment - Medium
Regular Platform

Internal Hex Compatible* | TAP-SV-RP10M | TAP-SV-RP20M | TAP-SV-RP30M

Straight Transfer Abutment - Long
Regular Platform

Internal Hex Compatible* | TAP-SV-RP10L | TAP-SV-RP20L | TAP-SV-RP30L

Angled Transfer Abutment - 15°
Regular Platform

Internal Hex Compatible* | TAP-SV-RP1510 | TAP-SV-RP1520 | TAP-SV-RP1530

Angled Transfer Abutment - 25°
Regular Platform

Internal Hex Compatible* | TAP-SV-RP2510 | TAP-SV-RP2520 | TAP-SV-RP2530

* Registered trademarks are owned by their respective companies and there is no commercial relationship with Edison Medical. Its mention is made for proper identification purpose of the dental implants with which the Edison Medical abutments can be used.

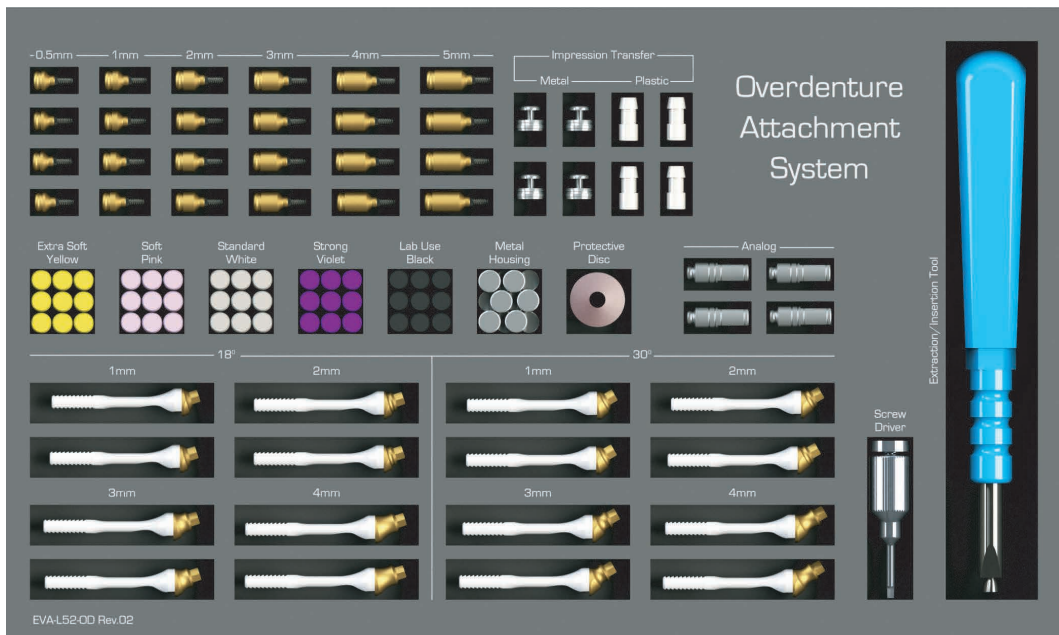

Professional Kit REF

Internal Hex
Compatible*

LOCW-SV-RPPK



OD-TK

Overdenture Tool KIT
for Insertion & Extraction
of Retentive Caps Suitable
for all Overdenture lines

Pop Clicq™ - Components



LOCW-RCV
Violet
2.7kg (4 pcs.)



LOCW-RCT
Transparent
1.8kg (4 pcs.)



LOCW-RCP
Pink
1.2kg (4 pcs.)



LOCW-RCY
Yellow
0.6kg (4 pcs.)



LOCW-RCB
Black
laboratory (4 pcs.)

Retentive Cap

Metal Housing



LOCW-MH

Pick-Up Impression Transfer
Assembled with
Yellow Retentive Cap



LOCW-PU

Analog for
Abutment



LOCW-AN

Protective Disc



LOCW-PD

* Registered trademarks are owned by their respective companies and there is no commercial relationship with Edison Medical. Its mention is made for proper identification purpose of the dental implants with which the Edison Medical abutments can be used.

Internal Hex



Pop Clicq™
Mini Kit



Straight Titanium Pop-Clicq™ - Mini Kit
Regular Platform



H	0.5mm	1mm	2mm	3mm
Internal Hex Compatible*	LOCW-SV-RP05K	LOCW-SV-RP10K	LOCW-SV-RP20K	LOCW-SV-RP30K



H	4mm	5mm	6mm
Internal Hex Compatible*	LOCW-SV-RP40K	LOCW-SV-RP50K	LOCW-SV-RP60K

Angled Titanium Pop-Clicq™ - 18°
Regular Platform



H	1mm	2mm	3mm	4mm
Internal Hex Compatible*	LOCW-SV-RP1805K	LOCW-SV-RP1810K	LOCW-SV-RP1820K	LOCW-SV-RP1830K

Angled Titanium Pop-Clicq™ - 30°
Regular Platform



H	1mm	2mm	3mm	4mm
Internal Hex Compatible*	LOCW-SV-RP3005K	LOCW-SV-RP3010K	LOCW-SV-RP3020K	LOCW-SV-RP3030K

* Registered trademarks are owned by their respective companies and there is no commercial relationship with Edison Medical. Its mention is made for proper identification purpose of the dental implants with which the Edison Medical abutments can be used.



Kits REF (Type A)

LOCW-BK2

LOCW-BK2D (Screw Driver Included)

Kits REF (Type B)

LOCW-BK4

LOCW-BK4D (Screw Driver Included)

Pop Clicq™ - Bar Components

 Bars *2

 (A) Adjustable Metal Housing *2
(B) Adjustable Metal Housing *4
(With a fixed screw)

 Pop Clicq™ Bar
(A) Metal Housing Tool \ Adapter *2
(B) Metal Housing Tool \ Adapter *4



(A) Analog for Pop Clicq™ Abutment *2
(B) Analog for Pop Clicq™ Abutment *4



(A) Pick-Up Impression Transfer *2
(B) Pick-Up Impression Transfer *4



Adjusting Screws for
(A) Metal Housing *3 (Incl. spares)
(B) Metal Housing *6 (Incl. spares)

* Registered trademarks are owned by their respective companies and there is no commercial relationship with Edison Medical. Its mention is made for proper identification purpose of the dental implants with which the Edison Medical abutments can be used.



Ball Attachment
Regular Platform

H

1mm 2mm 3mm 4mm 5mm 6mm

Internal Hex
Compatible* BAT-SV-RP10 BAT-SV-RP20 BAT-SV-RP30 BAT-SV-RP40 BAT-SV-RP50 BAT-SV-RP60

Ball Attachment - Standard Kit
Regular Platform

BAT-SV-RP10T BAT-SV-RP20T BAT-SV-RP30T BAT-SV-RP40T BAT-SV-RP50T BAT-SV-RP60T

Include:
 BAT-MH (Metal Housing)
 BAT-RCT (Retentive Cap - Transparent)
 LOCN-PD (Protective Disc)

BAT-SV-RP10P BAT-SV-RP20P BAT-SV-RP30P BAT-SV-RP40P BAT-SV-RP50P BAT-SV-RP60P

Include:
 BAT-MH (Metal Housing)
 BAT-RCP (Retentive Cap - Pink)
 LOCN-PD (Protective Disc)

Ball Attachment - Components

Retentive Cap					Metal Housing	
BAT-RCT Transparent Slightly elastic 1.2kg - 1.3kg (4 pcs.)	BAT-RCP Pink Elastic 0.8kg - 0.85kg (4 pcs.)	BAT-RCY Yellow Very elastic 0.5kg - 0.55kg (4 pcs.)	BAT-RCG Green Extremely elastic Up to 0.5kg (4 pcs.)	BAT-RCB Black laboratory (4 pcs.)	BAT-MH	
					Protective Disc	
					LOCN-PD	

* Registered trademarks are owned by their respective companies and there is no commercial relationship with Edison Medical. Its mention is made for proper identification purpose of the dental implants with which the Edison Medical abutments can be used.

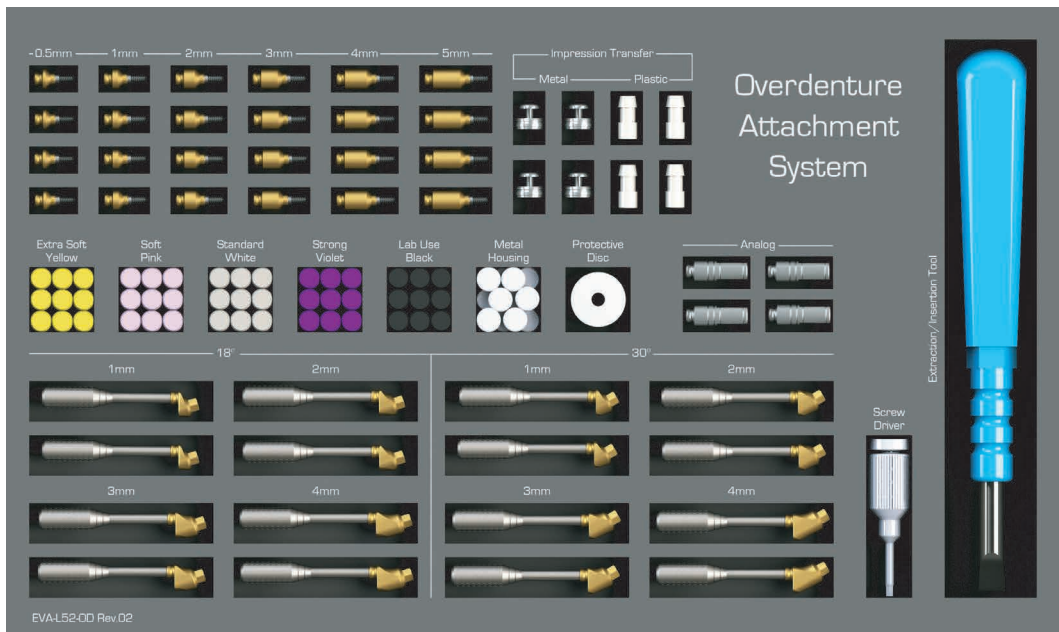

Professional Kit REF

Internal Hex
Compatible*

LOCN-SV-RPPK



Q Clicq™ - Components

					
LOCN-RCV Violet 2.7kg (4 pcs.)	LOCN-RCT Transparent 1.8kg (4 pcs.)	LOCN-RCP Pink 1.2kg (4 pcs.)	LOCN-RCY Yellow 0.6kg (4 pcs.)	LOCN-RCB Black laboratory (4 pcs.)	Metal Housing LOCN-MH
					
LOCN-PT	LOCN-PU	LOCN-AN	SMUL-SV-1.72	LOCN-PD	OD-TK Overdenture Tool KIT for Insertion & Extraction of Retentive Caps Suitable for all Overdenture lines

* Registered trademarks are owned by their respective companies and there is no commercial relationship with Edison Medical. Its mention is made for proper identification purpose of the dental implants with which the Edison Medical abutments can be used.

Internal Hex



Q-Clcq™ Mini Kit - Titanium



Straight Titanium Q-Clcq™ Regular Platform



H	0.5mm	1mm	2mm	3mm
Internal Hex Compatible*	LOCN-SV-RP05K	LOCN-SV-RP10K	LOCN-SV-RP20K	LOCN-SV-RP30K

H	4mm	5mm	6mm	7mm
Internal Hex Compatible*	LOCN-SV-RP40K	LOCN-SV-RP50K	LOCN-SV-RP60K	LOCN-SV-RP70K

Angled Titanium Q-Clcq™ - 18° Regular Platform

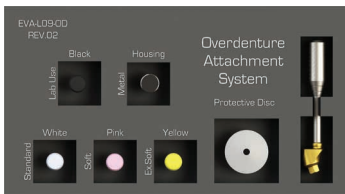

H	1mm	2mm	3mm	4mm
Internal Hex Compatible*	LOCN-SV-RP1810	LOCN-SV-RP1820	LOCN-SV-RP1830	LOCN-SV-RP1840

Angled Titanium Q-Clcq™ - 30° Regular Platform



H	1mm	2mm	3mm	4mm
Internal Hex Compatible*	LOCN-SV-RP3010	LOCN-SV-RP3020	LOCN-SV-RP3030	LOCN-SV-RP3040

* Registered trademarks are owned by their respective companies and there is no commercial relationship with Edison Medical. Its mention is made for proper identification purpose of the dental implants with which the Edison Medical abutments can be used.



Professional Kit REF

Internal Hex
Compatible *

MUL-SV-RPPK

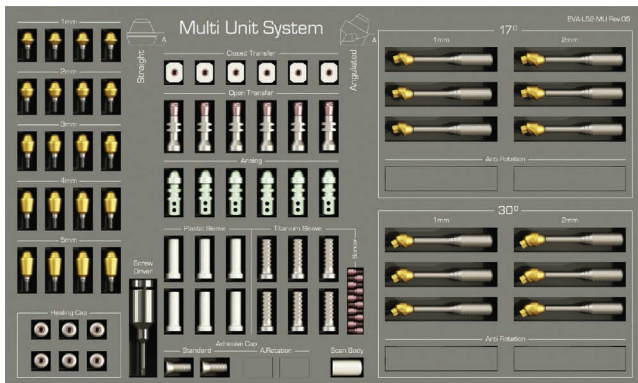

Starter Kit REF

Internal Hex
Compatible *

MUL-SV-RPSK

Multi Clicq™ - Components

Abutment Analog



Closed Tray Plastic Transfer

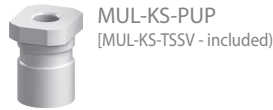

Castable Plastic Sleeve



Cobalt Sleeve UCLA



Open Tray Transfer



Healing cap

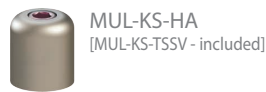

Scan Body (Peek)



Temporary Titanium Sleeve



Rotational Titanium Base



Anti Rotational Titanium Base

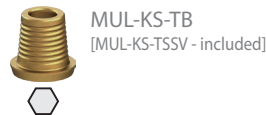

Rotational Adhesive Cap



Anti Rotational Adhesive Cap



Prosthetic Titanium Screw



* Registered trademarks are owned by their respective companies and there is no commercial relationship with Edison Medical. Its mention is made for proper identification purpose of the dental implants with which the Edison Medical abutments can be used.

Internal Hex



Multi Clicq™ - On4/On6

Mini & Standard Kit

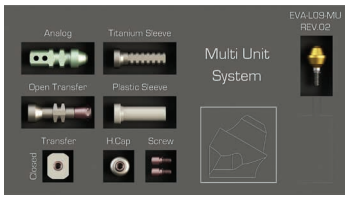

Straight Mini Kit
Regular Platform



H

1mm

2mm

3mm

4mm

5mm

6mm

Internal Hex
Compatible*

MUL-SV-RPKS10K

MUL-SV-RPKS20K

MUL-SV-RPKS30K

MUL-SV-RPKS40K

MUL-SV-RPKS50K

MUL-SV-RPKS60K



Straight Abutment
Regular Platform



H



1mm

2mm

3mm

4mm

5mm

6mm

Internal Hex
Compatible*

MUL-SV-RPKS10

MUL-SV-RPKS20

MUL-SV-RPKS30

MUL-SV-RPKS40

MUL-SV-RPKS50

MUL-SV-RPKS60

* Registered trademarks are owned by their respective companies and there is no commercial relationship with Edison Medical. Its mention is made for proper identification purpose of the dental implants with which the Edison Medical abutments can be used.

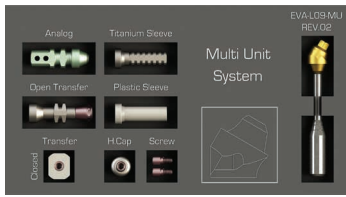

One Piece Angled 17°
Abutment Mini Kit
Regular Platform



G	1mm	2mm
H	2.5mm	3.5mm
Internal Hex Compatible*	MUL-SV-RPKS1710K	MUL-SV-RPKS1720K

One Piece Angled 30°
Abutment Mini Kit
Regular Platform



G	1mm	2mm
H	3.5mm	4.5mm
Internal Hex Compatible*	MUL-SV-RPKS3010K	MUL-SV-RPKS3020K



One Piece Angled Abutment - 17°
Standard Kit
Regular Platform

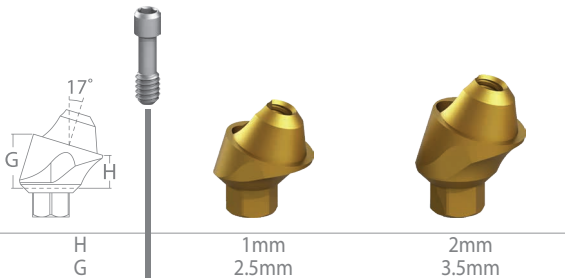

H	1mm	2mm
G	2.5mm	3.5mm
Internal Hex Compatible*	MUL-SV-RPKS1710	MUL-SV-RPKS1720

One Piece Angled Abutment - 30°
Standard Kit
Regular Platform

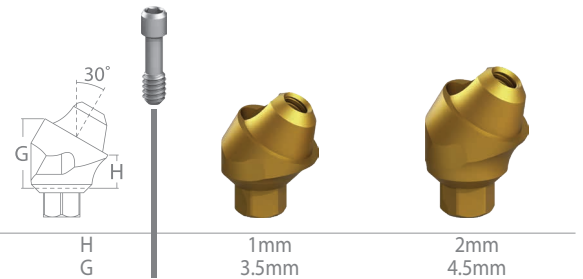

H	1mm	2mm
G	3.5mm	4.5mm
Internal Hex Compatible*	MUL-SV-RPKS3010	MUL-SV-RPKS3020

Anti-Rotational - One Piece Angled Abutment - 17°
Standard Kit
Regular Platform

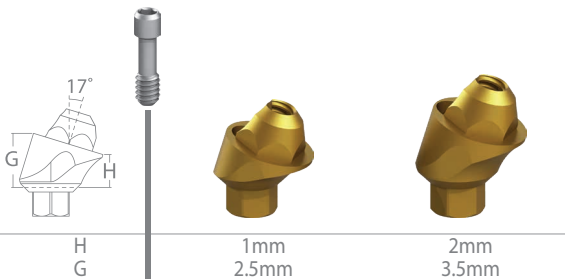

H	1mm	2mm
G	2.5mm	3.5mm
Internal Hex Compatible*	MUL-SV-RPKS1710H	MUL-SV-RPKS1720H

Anti-Rotational - One Piece Angled Abutment - 30°
Standard Kit
Regular Platform

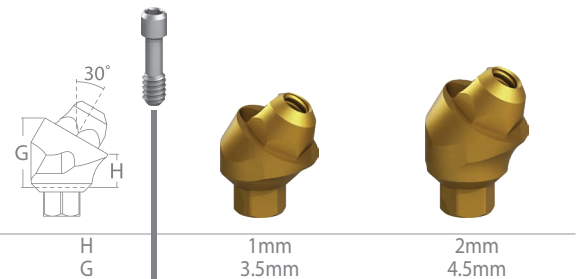

H	1mm	2mm
G	3.5mm	4.5mm
Internal Hex Compatible*	MUL-SV-RPKS3010H	MUL-SV-RPKS3020H

* Registered trademarks are owned by their respective companies and there is no commercial relationship with Edison Medical. Its mention is made for proper identification purpose of the dental implants with which the Edison Medical abutments can be used.



Design Patent Pending No. 62154
Patent Pending No. US 62/679,389



Clicq™ - Multi Bar On4 Kit
Regular Platform



(Screw Driver Included)

Internal Hex
Compatible*

MUL-SV-BK4

MUL-SV-BK4D

Clicq™ - Multi Bar On6 Kit
Regular Platform



(Screw Driver Included)

Internal Hex
Compatible*

MUL-SV-BK6

MUL-SV-BK6D

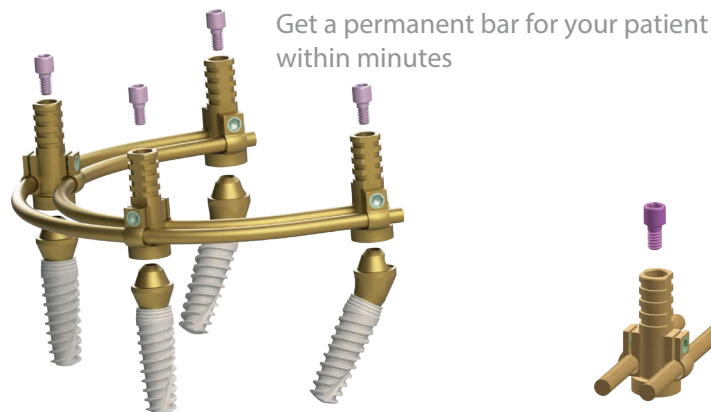

Get a permanent bar for your patient
within minutes

Clicq™ - Multi Bar Components



Bars *2



Adjusting Micro Screw *2
(spares)



Prosthetic KS Ti-Screw
On 4 - *6 (Incl. 2 spares)
On 6 - *8 (Incl. 2 spares)



Pre-Fabricated Permanent
Titanium Adjustable Sleeve *4/6
with Adjusting Micro Screw *8/12



Hand Screw Driver

* Registered trademarks are owned by their respective companies and there is no commercial relationship with Edison Medical. Its mention is made for proper identification purpose of the dental implants with which the Edison Medical abutments can be used.



Zircocam™ - Straight Anatomic Abutment
Regular Platform

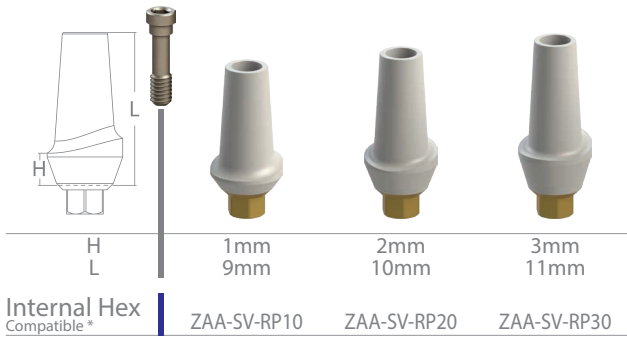

Zircocam™ - Angled Anatomic Abutment 15°
Regular Platform

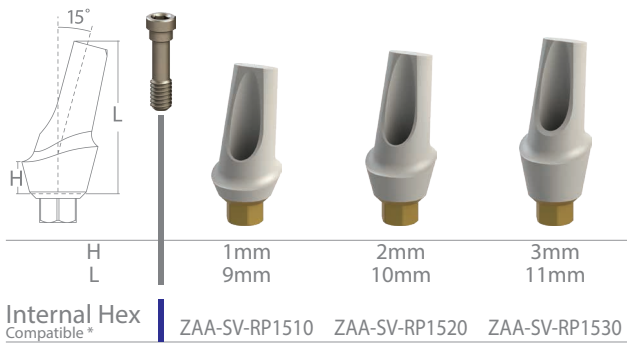

Zircocam™ - Angled Anatomic Abutment 25°
Regular Platform

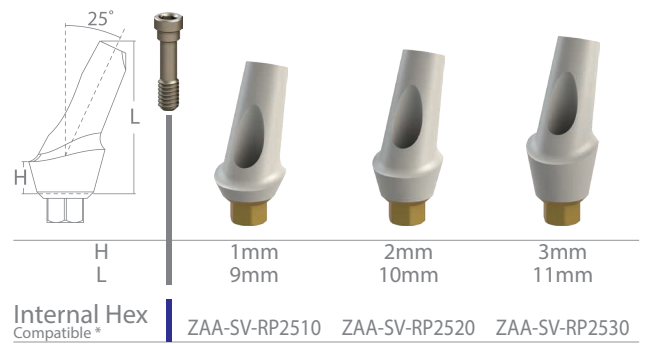

Zircotec™ - Straight Anatomic Abutment
Regular Platform

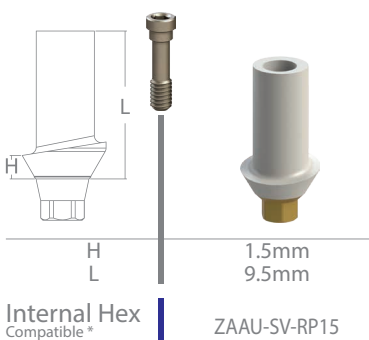

Zircotec™ - Angled Anatomic Abutment 15°
Regular Platform

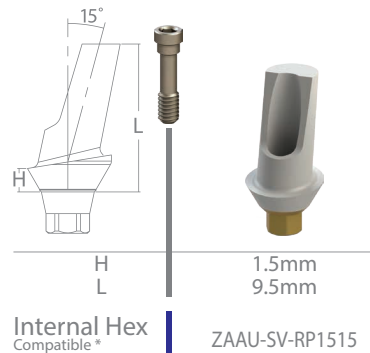

* Registered trademarks are owned by their respective companies and there is no commercial relationship with Edison Medical. Its mention is made for proper identification purpose of the dental implants with which the Edison Medical abutments can be used.



Plastic Abutment for Casting
Regular Platform

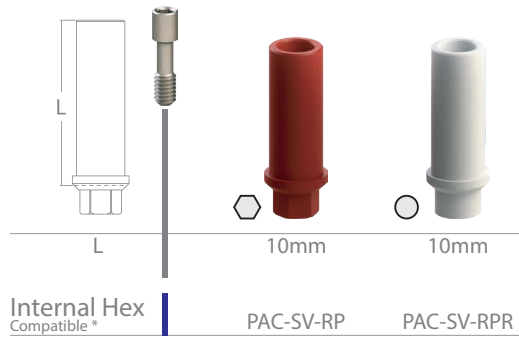

Titanium Abutment / UCLA
Regular Platform

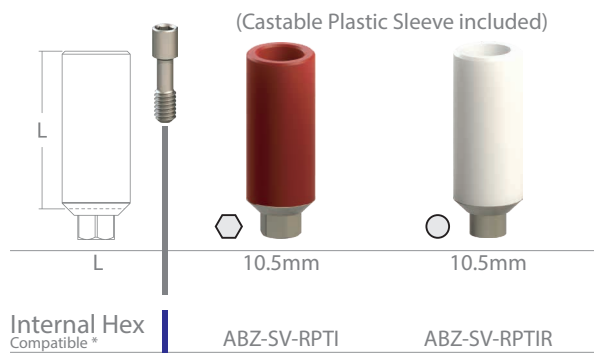

Chrome Cobalt Abutment / UCLA
Regular Platform

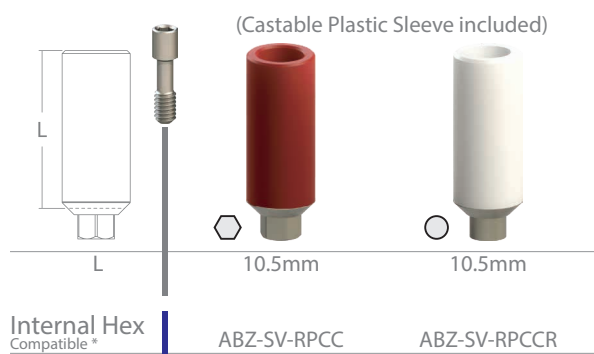

* Registered trademarks are owned by their respective companies and there is no commercial relationship with Edison Medical. Its mention is made for proper identification purpose of the dental implants with which the Edison Medical abutments can be used.



Scan Abutment
Regular Platform

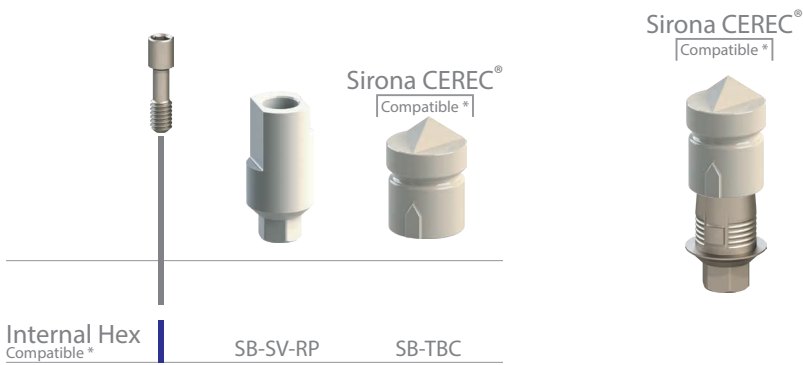

Titanium Base
Regular Platform

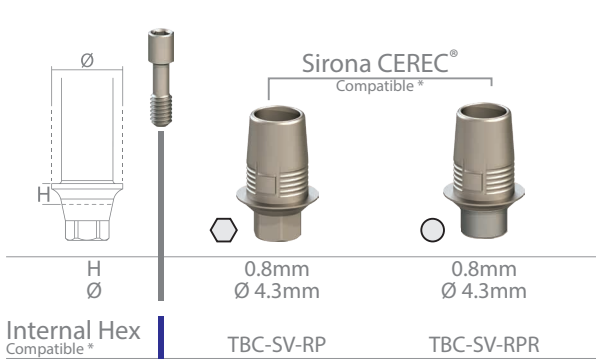

Angled Titanium Base 10°
Regular Platform

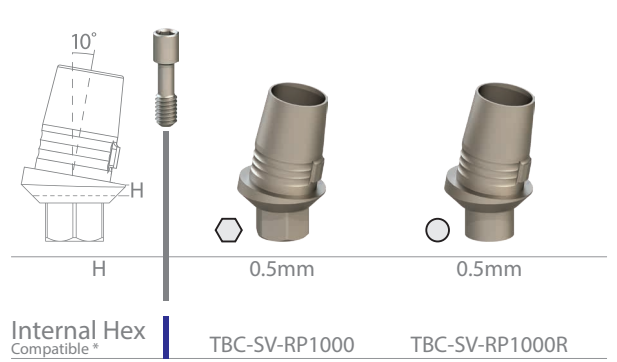

Pre-Milled Titanium Blank
Regular Platform

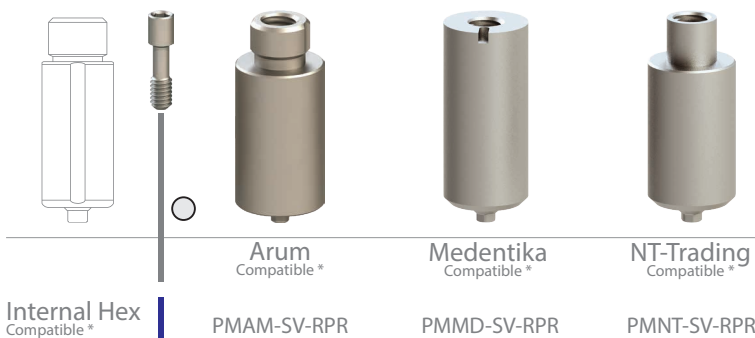
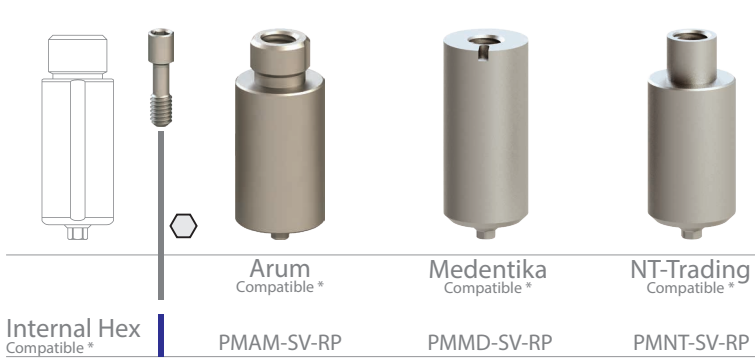

* Registered trademarks are owned by their respective companies and there is no commercial relationship with Edison Medical. Its mention is made for proper identification purpose of the dental implants with which the Edison Medical abutments can be used.

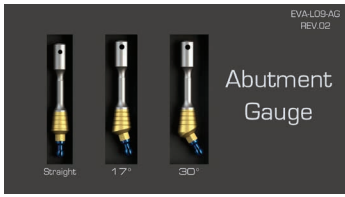

Abutment Gauge Kit
Regular Platform

Internal Hex
Compatible* | AG-SV-RPK

Abutment Gauge Straight
Regular Platform

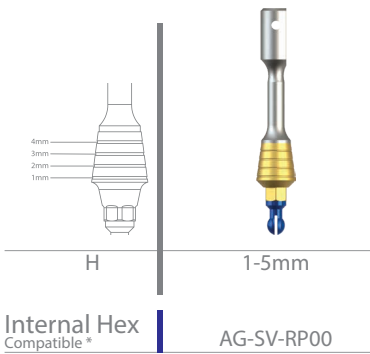

Abutment Gauge - 17°
Regular Platform

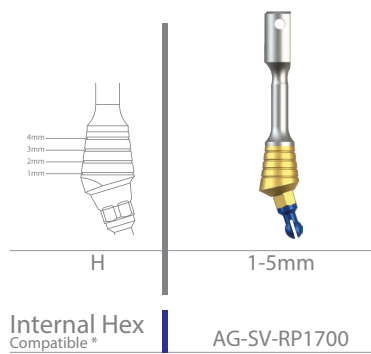

Abutment Gauge - 30°
Regular Platform

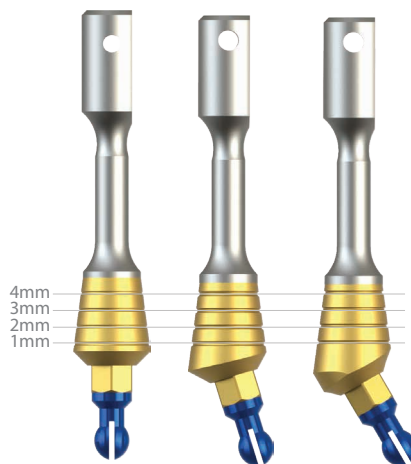
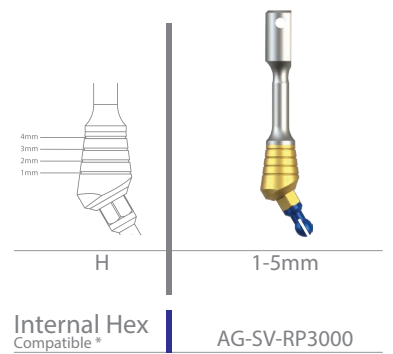

* Registered trademarks are owned by their respective companies and there is no commercial relationship with Edison Medical. Its mention is made for proper identification purpose of the dental implants with which the Edison Medical abutments can be used.





—  ***Tools***  —





Tools For Implants

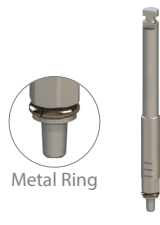

Motor Mount for Implant - Self Loading Regular Platform

 H		 22mm	 28mm
NobelActive™ Compatible*		MDIO-NA-RPS	MDIO-NA-RPL
Osstem® Hiossen® Compatible*		MDIO-TS-RPS	MDIO-TS-RPL
Dentium® Compatible*		MDIO-DE-RPS	MDIO-DE-RPL
MegaGen® AnyOne Compatible*		MDIO-AO-RPS	MDIO-AO-RPL
MegaGen® AnyRidge Compatible*		MDIO-AR-RPS	MDIO-AR-RPL
Astra Tech™TX Compatible*		MDIO-OS-WPS	MDIO-OS-WPL
Dio Implant® Compatible*		MDIO-UF-RPS	MDIO-UF-RPL
NeoBiotech® Compatible*		MDIO-IS-RPS	MDIO-IS-RPL
Internal Hex Compatible*		MDIO-SV-RPS	MDIO-SV-RPL

Motor Mount for Implant - Self Loading Narrow Platform

 L		 22mm	 28mm
NobelActive™ Compatible*		MDIO-NA-NPS	MDIO-NA-NPL
Osstem® Hiossen® Compatible*		MDIO-TS-NPS	MDIO-TS-NPL
Astra Tech™TX Compatible*		MDIO-OS-SPS	MDIO-OS-SPL

* Registered trademarks are owned by their respective companies and there is no commercial relationship with Edison Medical. Its mention is made for proper identification purpose of the dental implants with which the Edison Medical abutments can be used.



Tools For Implants



Ratchet Driver for Implant - Self Loading Regular Platform



L	9mm	12mm	17mm
NobelActive™ Compatible*	RDIO-NA-RPXS	RDIO-NA-RPS	RDIO-NA-RPL
Osstem® Hiossen® Compatible*	RDIO-TS-RPXS	RDIO-TS-RPS	RDIO-TS-RL
Dentium® Compatible*	RDIO-DE-RPXS	RDIO-DE-RPS	RDIO-DE-RPL
MegaGen® AnyOne Compatible*	RDIO-AO-RPXS	RDIO-AO-RPS	RDIO-AO-RPL
MegaGen® AnyRidge Compatible*	RDIO-AR-RPXS	RDIO-AR-RPS	RDIO-AR-RPL
Astra Tech™TX Compatible*	RDIO-OS-WPXS	RDIO-OS-WPS	RDIO-OS-WPL
Dio Implant® Compatible*	RDIO-UF-RPXS	RDIO-UF-RPS	RDIO-UF-RPL
NeoBiotech® Compatible*	RDIO-IS-RPXS	RDIO-IS-RPS	RDIO-IS-RPL
Internal Hex Compatible*	RDIO-SV-RPXS	RDIO-SV-RPS	RDIO-SV-RPL

Ø 8mm

Ø 7mm

Ratchet Driver for Implant - Self Loading Regular Platform

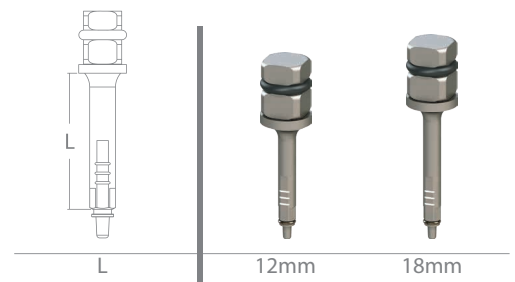

L	12mm	18mm
NobelActive™ Compatible*	TDIO-NA-RPS	TDIO-NA-RPL
Osstem® Hiossen® Compatible*	TDIO-TS-RPS	TDIO-TS-RPL
Dentium® Compatible*	TDIO-DE-RPS	TDIO-DE-RPL
MegaGen® AnyOne Compatible*	TDIO-AO-RPS	TDIO-AO-RPL
MegaGen® AnyRidge Compatible*	TDIO-AR-RPS	TDIO-AR-RPL
Astra Tech™TX Compatible*	TDIO-OS-WPS	TDIO-OS-WPL
Dio Implant® Compatible*	TDIO-UF-RPS	TDIO-UF-RPL
NeoBiotech® Compatible*	TDIO-IS-RPS	TDIO-IS-RPL
Internal Hex Compatible*	TDIO-SV-RPS	TDIO-SV-RPL

Ratchet Driver for Implant - Self Loading Narrow Platform



L	9mm	12mm	17mm
NobelActive™ Compatible*	RDIO-NA-NPXS	RDIO-NA-NPS	RDIO-NA-NPL
Osstem® Hiossen® Compatible*	RDIO-TS-NPXS	RDIO-TS-NPS	RDIO-TS-NPL
Astra Tech™TX Compatible*	RDIO-OS-SPXS	RDIO-OS-SPS	RDIO-OS-SPL

Ø 8mm

Ø 7mm

Ratchet Driver for Implant - Self Loading Narrow Platform

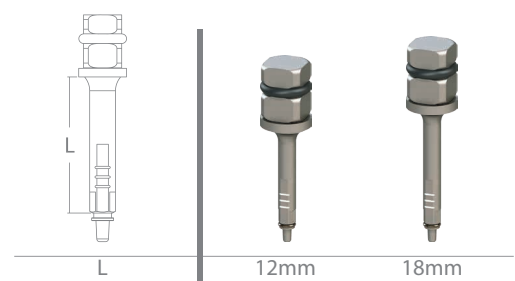

L	12mm	18mm
NobelActive™ Compatible*	TDIO-NA-NPS	TDIO-NA-NPL
Osstem® Hiossen® Compatible*	TDIO-TS-NPS	TDIO-TS-NPL
Astra Tech™TX Compatible*	TDIO-OS-SPS	TDIO-OS-SPL



* Registered trademarks are owned by their respective companies and there is no commercial relationship with Edison Medical. Its mention is made for proper identification purpose of the dental implants with which the Edison Medical abutments can be used.



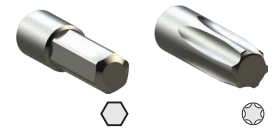

Tools For Screw



Motor Mount for Screw Regular Platform

 L	22mm	28mm	
NobelActive™ Compatible *	MDS-NA-S	MDS-NA-L	
Osstem® Hiossen® Compatible *	MDS-TS-S	MDS-TS-L	
Dentium® Compatible *	MDS-DE-S	MDS-DE-L	
MegaGen® AnyOne Compatible *	MDS-AO-S	MDS-AO-L	
MegaGen® AnyRidge Compatible *	MDS-AR-S	MDS-AR-L	
Astra Tech™TX Compatible *	MDS-OS-S	MDS-OS-L	
Dio Implant® Compatible *	MDS-UF-S	MDS-UF-L	
NeoBiotech® Compatible *	MDS-IS-S	MDS-IS-L	
Internal Hex Compatible *	MDS-SV-S	MDS-SV-L	

Ratchet Driver for Screw Regular Platform

 L	12mm	18mm	
NobelActive™ Compatible *	TDS-NA-RPS	TDS-NA-RPL	
Osstem® Hiossen® Compatible *	TDS-TS-RPS	TDS-TS-RPL	
Dentium® Compatible *	TDS-DE-RPS	TDS-DE-RPL	
MegaGen® AnyOne Compatible *	TDS-AO-RPS	TDS-AO-RPL	
MegaGen® AnyRidge Compatible *	TDS-AR-RPS	TDS-AR-RPL	
Astra Tech™TX Compatible *	TDS-OS-WPS	TDS-OS-WPL	
Dio Implant® Compatible *	TDS-UF-RPS	TDS-UF-RPL	
NeoBiotech® Compatible *	TDS-IS-RPS	TDS-IS-RPL	
Internal Hex Compatible *	TDS-SV-RPS	TDS-SV-RPL	





* Registered trademarks are owned by their respective companies and there is no commercial relationship with Edison Medical. Its mention is made for proper identification purpose of the dental implants with which the Edison Medical abutments can be used.

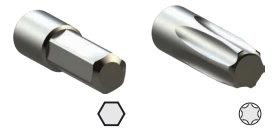



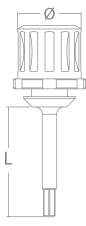

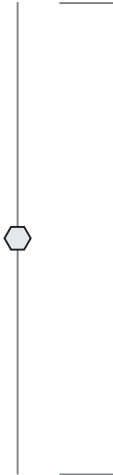

Tools For Screw

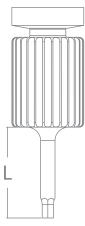

Ratchet Driver for Screw Regular Platform

				
L		22mm	28mm	
NobelActive™ Compatible *		RDS-NA-S	RDS-NA-L	 Ø 8mm
Osstem® Hiossen® Compatible *		RDS-TS-S	RDS-TS-L	 Ø 7mm
Dentium® Compatible *		RDS-DE-S	RDS-DE-L	
MegaGen® AnyOne Compatible *		RDS-AO-S	RDS-AO-L	
MegaGen® AnyRidge Compatible *		RDS-AR-S	RDS-AR-L	
Astra Tech™TX Compatible *		RDS-OS-S	RDS-OS-L	
Dio Implant® Compatible *		RDS-UF-S	RDS-UF-L	
NeoBiotech® Compatible *		RDS-IS-S	RDS-IS-L	
Internal Hex Compatible *		MDS-SV-S	MDS-SV-L	

Hand Screw Driver Regular Platform

					
L		10mm	15mm	30mm	
NobelActive™ Compatible *		HSDA-NA-S	HSDA-NA-L	HSDA-NA-XL	
Osstem® Hiossen® Compatible *		HSDA-TS-S	HSDA-TS-L	HSDA-TS-XL	 Ø 7mm
Dentium® Compatible *		HSDA-DE-S	HSDA-DE-L	HSDA-DE-XL	
MegaGen® AnyOne Compatible *		HSDA-AO-S	HSDA-AO-L	HSDA-AO-XL	
MegaGen® AnyRidge Compatible *		HSDA-AR-S	HSDA-AR-L	HSDA-AR-XL	
Astra Tech™TX Compatible *		HSDA-OS-S	HSDA-OS-L	HSDA-OS-XL	
Dio Implant® Compatible *		HSDA-UF-S	HSDA-UF-L	HSDA-UF-XL	
NeoBiotech® Compatible *		HSDA-IS-S	HSDA-IS-L	HSDA-IS-XL	
Internal Hex Compatible *		HSDA-SV-S	HSDA-SV-L	HSDA-SV-XL	



* Registered trademarks are owned by their respective companies and there is no commercial relationship with Edison Medical. Its mention is made for proper identification purpose of the dental implants with which the Edison Medical abutments can be used.





Tools Drills





Drill Extender External Irrigation

	
L	14mm
REF	DEXT

Lance Drill External Irrigation

	
L	6mm
REF	LD-2.0-06

Dual Drill Ø 2.0mm External Irrigation

	
L	6mm
REF	DELD-2.0-06

Step drills - Ø 2.0mm External Irrigation

				
L	10mm	11.5mm	13mm	15mm
REF	SD-2.0-10	SD-2.0-11	SD-2.0-13	SD-2.0-15

Step drills - Ø 2.7mm External Irrigation

				
L	10mm	11.5mm	13mm	15mm
REF	SD-2.7-10	SD-2.7-11	SD-2.7-13	SD-2.7-15

* Registered trademarks are owned by their respective companies and there is no commercial relationship with Edison Medical. Its mention is made for proper identification purpose of the dental implants with which the Edison Medical abutments can be used.



Tools Drills



Step drills - Ø 3.1mm External Irrigation

L	8mm	10mm	11.5mm	13mm	15mm
REF	SD-3.1-08	SD-3.1-10	SD-3.1-11	SD-3.1-13	SD-3.1-15

Step drills - Ø 3.7mm External Irrigation

H (mm)	8mm	10mm	11.5mm	13mm	15mm
REF	SD-3.7-8	SD-3.7-10	SD-3.7-11	SD-3.7-13	SD-3.7-15

Step drills - Ø 4.4mm External Irrigation

L	8mm	10mm	11.5mm	13mm
REF	SD-4.4-8	SD-4.4-10	SD-4.4-11	SD-4.4-13

* Registered trademarks are owned by their respective companies and there is no commercial relationship with Edison Medical. Its mention is made for proper identification purpose of the dental implants with which the Edison Medical abutments can be used.



Tools Drills



Twist Step Drills External Irrigation

Ø1	2.4mm	2.7mm	3.1mm	3.7mm	4.4mm
Ø2	2.0mm	2.4mm	2.7mm	3.1mm	3.7mm
REF	TSD-2.4-15	TSD-2.7-15	TSD-3.1-15	TSD-3.7-15	TSD-4.4-15

Stoppers for Standard Twist Drills

REF	DSTD-13	DSTD-11.5	DSTD-10	DSTD-8

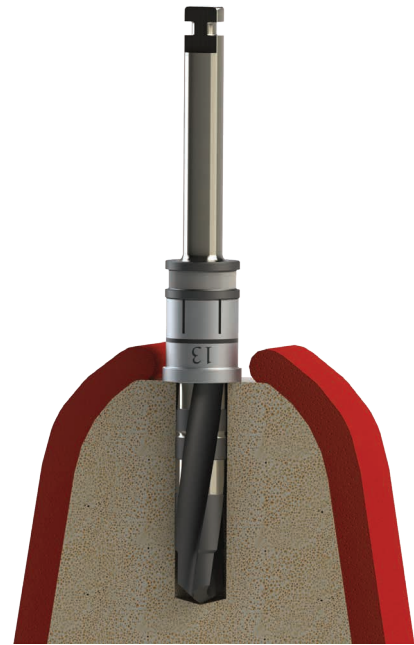

Hard Bone Drills Regular Platform

Ø1	3.5mm	5.0mm
Ø2	3.1mm	4.2mm
REF	HBD-3.5	HBD-5.0

Trepine Burs Regular Platform

Ø1	3mm	4mm
Ø2	4mm	5mm
REF	TB-3.0-4.0	TB-4.0-5.0

* Registered trademarks are owned by their respective companies and there is no commercial relationship with Edison Medical. Its mention is made for proper identification purpose of the dental implants with which the Edison Medical abutments can be used.

Tools



RW-UH 
Ratchet Wrench
Black Marking w/6.35mm Hex

RW-UTS 
Ratchet Wrench
Black Marking w/Square TS 4mm



RT-45H 
Torque Ratchet 0-45 Ncm
Black Marking w/6.35 Hex

RT-45TS 
Torque Ratchet 0-45 Ncm
Black Marking w/Square TS 4mm



RT-70ST 
Torque Ratchet 0-70 Ncm
Black Marking, Ø - 7mm

RT-70TSSQ 
Torque Ratchet 0-70 Ncm
Black Marking, Square TS 4mm



IPR-S
Implant Deep Probe - Single End



IPR-D
Implant Deep Probe

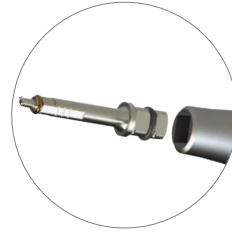

HDR 
Hand Driver suitable for
Squar Ratchet Driver
(Ratchet driver not Incd.)

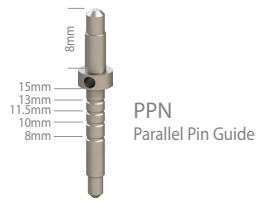

PPN
Parallel Pin Guide



MM-ADP-8
Motor Mount Adapter
w/Ball Friction 8mm

MM-ADP-7
Motor Mount Adapter
w/Ball Friction 7mm



TS-ADP-8
Ratchet Adapter
from Square 4mm
to Round Ø 8mm

TS-ADP-7
Ratchet Adapter
from Square 4mm
to Round Ø 7mm

* Registered trademarks are owned by their respective companies and there is no commercial relationship with Edison Medical. Its mention is made for proper identification purpose of the dental implants with which the Edison Medical abutments can be used.



REF RSB-AR-SK

Surgical Tool Box - Artic Components

Lance Drill:
LD-2.0-06

Drill Extender:
DEXT

Twist Step Drills:
TSD-2.4-15
TSD-2.7-15
TSD-3.1-15
TSD-3.7-15
TSD-4.4-15

Hard Bone Drills:
HBD-3.5
HBD-5.0

Stoppers for Twist Drills:
DSTD-13 *2
DSTD-11.5 *2
DSTD-10 *2
DSTD-8 *2

Parallel Pin:
PPN *3

Torque Ratchet 0-70 Ncm:
RT-70ST

Tools for Implants:

Ratchet Driver for Implant:
RDIO-NA-RPS
RDIO-NA-RPL
RDIO-NA-NPS
RDIO-NA-NPL

Motor Mount for Implant:
MDIO-NA-RPS
MDIO-NA-RPL
MDIO-NA-NPS
MDIO-NA-NPL

Tools for Screw:

Ratchet Driver for Screw:
RDS-SV-S
RDS-SV-L

Motor Mount for Screw:
MDS-SV-L

Hand Driver for Screw:
HSDA-SV-S
HSDA-SV-L

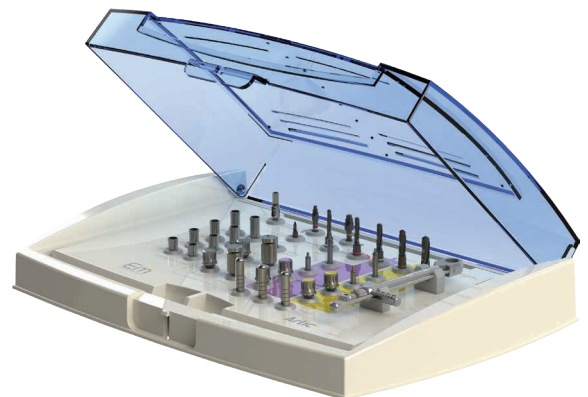

* Registered trademarks are owned by their respective companies and there is no commercial relationship with Edison Medical. Its mention is made for proper identification purpose of the dental implants with which the Edison Medical abutments can be used.



REF RSB-FR-SK

Surgical Tool Box - ios3/Fortis Components

Lance Drill:
LD-2.0-06

Drill Extender:
DEXT

Twist Step Drills:
TSD-2.4-15
TSD-2.7-15
TSD-3.1-15
TSD-3.7-15
TSD-4.4-15

Hard Bone Drills:
HBD-3.5
HBD-5.0

Stoppers for Twist Drills:
DSTD-13 *2
DSTD-11.5 *2
DSTD-10 *2
DSTD-8 *2

Parallel Pin:
PPN *3

Torque Ratchet 0-70 Ncm:
RT-70ST

Tools for Implants:

Ratchet Driver for Implant:
RDIO-TS-RPS
RDIO-TS-RPL
RDIO-OS-SPS
RDIO-OS-SPL

Motor Mount for Implant:
MDIO-TS-RPS
MDIO-TS-RPL
MDIO-OS-SPS
MDIO-OS-SPL

Tools for Screw:

Ratchet Driver for Screw:
RDS-SV-S
RDS-SV-L

Motor Mount for Screw:
MDS-SV-L

Hand Driver for Screw:
HSDA-SV-S
HSDA-SV-L

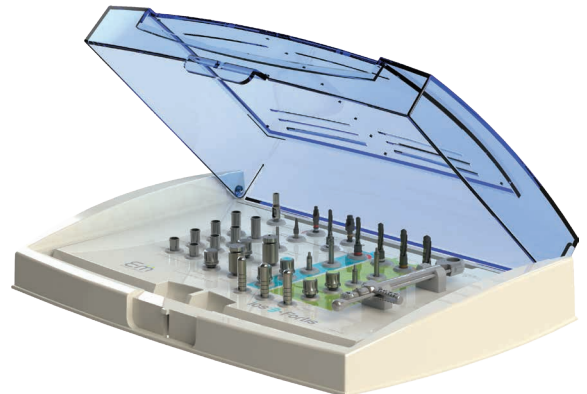

* Registered trademarks are owned by their respective companies and there is no commercial relationship with Edison Medical. Its mention is made for proper identification purpose of the dental implants with which the Edison Medical abutments can be used.



REF RSB-LM-SK

Surgical Tool Box - Lamina Components

Lance Drill:
LD-2.0-06

Drill Extender:
DEXT

Twist Step Drills:
TSD-2.4-15
TSD-2.7-15
TSD-3.1-15
TSD-3.7-15
TSD-4.4-15

Hard Bone Drills:
HBD-3.5
HBD-5.0

Stoppers for Twist Drills:
DSTD-13 *2
DSTD-11.5 *2
DSTD-10 *2
DSTD-8 *2

Parallel Pin:
PPN *3

Torque Ratchet 0-70 Ncm:
RT-70ST

Tools for Implants:

Ratchet Driver for Implant:
RDIO-SV-RPS
RDIO-SV-RPL

Motor Mount for Implant:
MDIO-SV-RPS
MDIO-SV-RPL

Tools for Screw:

Ratchet Driver for Screw:
RDS-SV-S
RDS-SV-L

Motor Mount for Screw:
MDS-SV-L

Hand Driver for Screw:
HSDA-SV-S
HSDA-SV-L

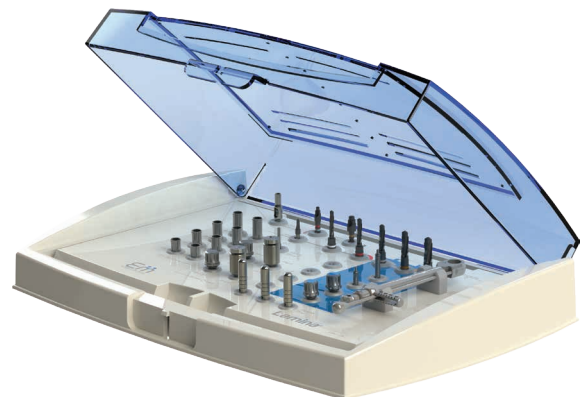

* Registered trademarks are owned by their respective companies and there is no commercial relationship with Edison Medical. Its mention is made for proper identification purpose of the dental implants with which the Edison Medical abutments can be used.